

MEISINGERDIGITAL.

Inspired by
the Future

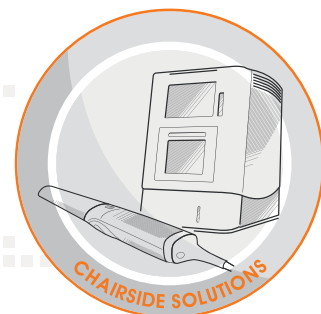

♥ Made for you!

MEISINGERDIGITAL.

Discover the digital World of MEISINGER

and create your
personal dental
innovations

with us!



PREFACE



Sebastian Bolling
Head of MEISINGER DIGITAL

Dentistry has always been influenced by technological developments and digitalization is and will be one of the turning points in the way that we work. Digitalization is much more than a passing trend. It has become a decisive technological development that will fundamentally influence the way we work - today and in the future. At MEISINGER DIGITAL, my colleagues and I are passionate about actively participating in this development. We want to offer you tailor-made digital solutions and increase the success and long-term efficiency of your daily practice.

How exactly can we achieve this? For example, through digitally planned models of teeth and jaws that look deceptively like their natural counterparts and can be used for dental education and training, surgical planning and patient information. Or with our intelligent chairside bundle of scanner, computer and milling machine, which allow you to design and manufacture your own prosthetics in an efficient workflow with maximum freedom. Or through digital implant planning from experienced hands, including precision-fit drilling guides for optimal implant placement. Numerous other examples could be added, but I think your curiosity is piqued and you want to find out for yourself what added value our digital team can offer you. With MEISINGER DIGITAL, the world of digital dentistry is open to you, and we are particularly pleased that this first catalog summarizes all our products and services in the digital field for you. We hope you enjoy discovering them!

Sebastian Bolling
and the whole MEISINGER DIGITAL team

YOUR DIGITAL-SERVICE TEAM

Behind every innovation are people committed to putting new ideas into practice with passion. With the MEISINGER DIGITAL team, you have access to a team of highly experienced experts to support you in utilizing the advantages and opportunities of digitalization in your practice or laboratory. We are here for you because our goal is to provide you and your patients with the sophisticated digital products and services to achieve the best possible outcome in all aspects.

Feel free to reach out to us:

Phone: 02131 2012-303

E-Mail: digital@meisinger.de



From left to right: Paul Delée (External Advisor MEISINGER DIGITAL), Sebastian Voss (CEO MEISINGER), Tim Drüke (Digital Production Unit Neuss), Sebastian Bolling (Head of MEISINGER DIGITAL), Frank Brüggem (Global Digital Manager, Guided Surgery)

From virtual planning to individual solutions - the four workflows of MEISINGER DIGITAL

Training & Education Models

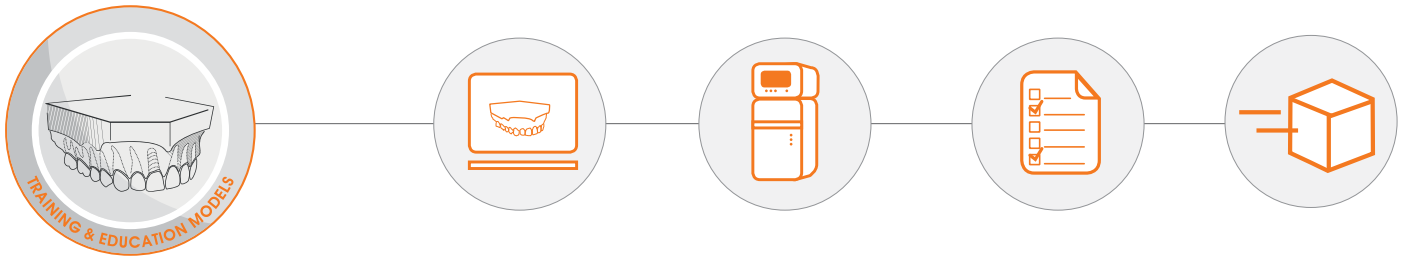

Chairside Solutions powered by imes-core®

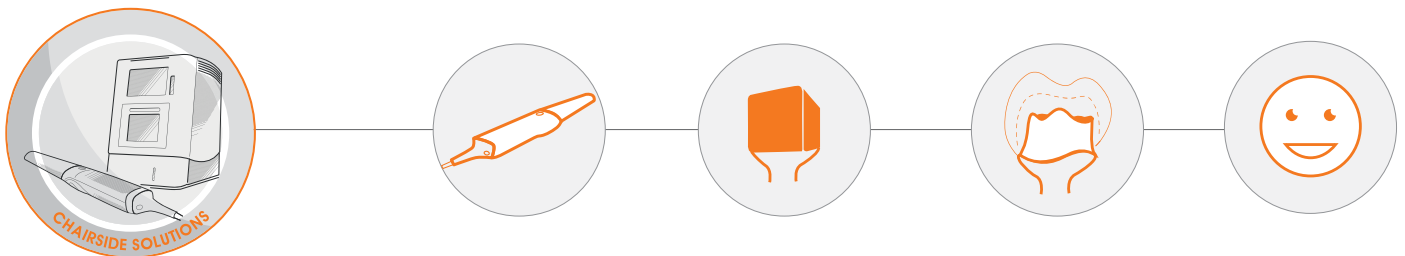

Digital planning and 3D-printed surgical guides for Implantology and Bone Management®

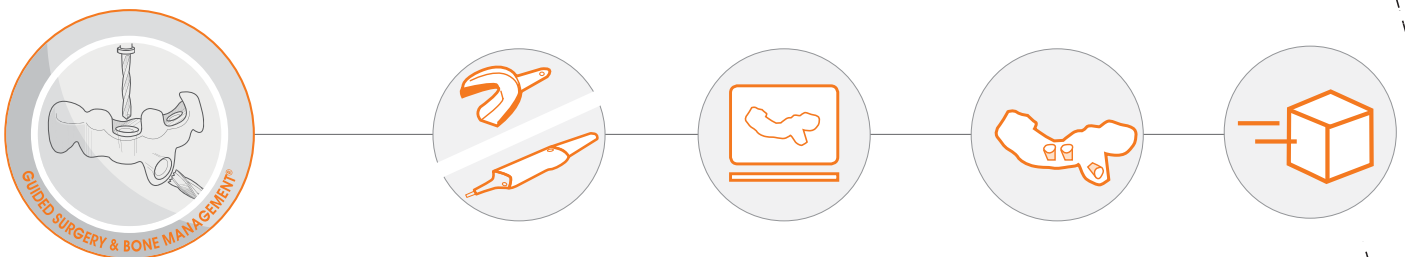

Customized abutments and prosthetics

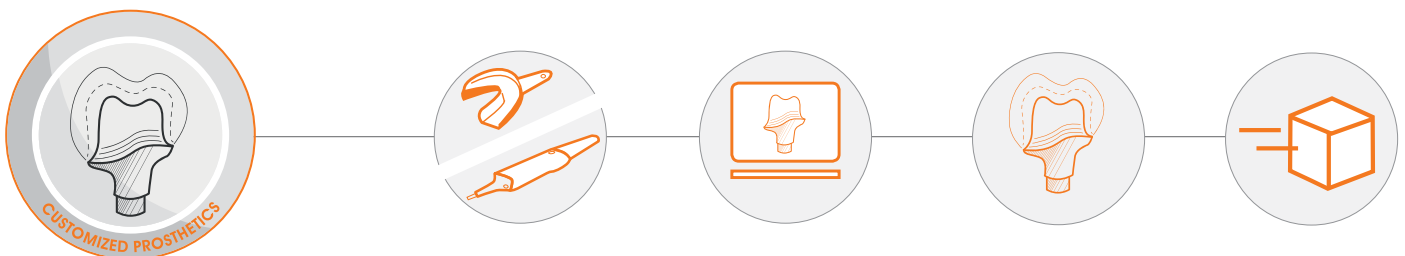



MEISINGER GROUP

- Founded in 1888 by Arthur Meisinger
- More than 40 years of experience in implantology
- Launch of Bone Management® in 1998
- Family-owned and family-managed
- Sales activities in more than 100 countries
- High-quality medical products made in Germany
- In-house R&D and production facilities

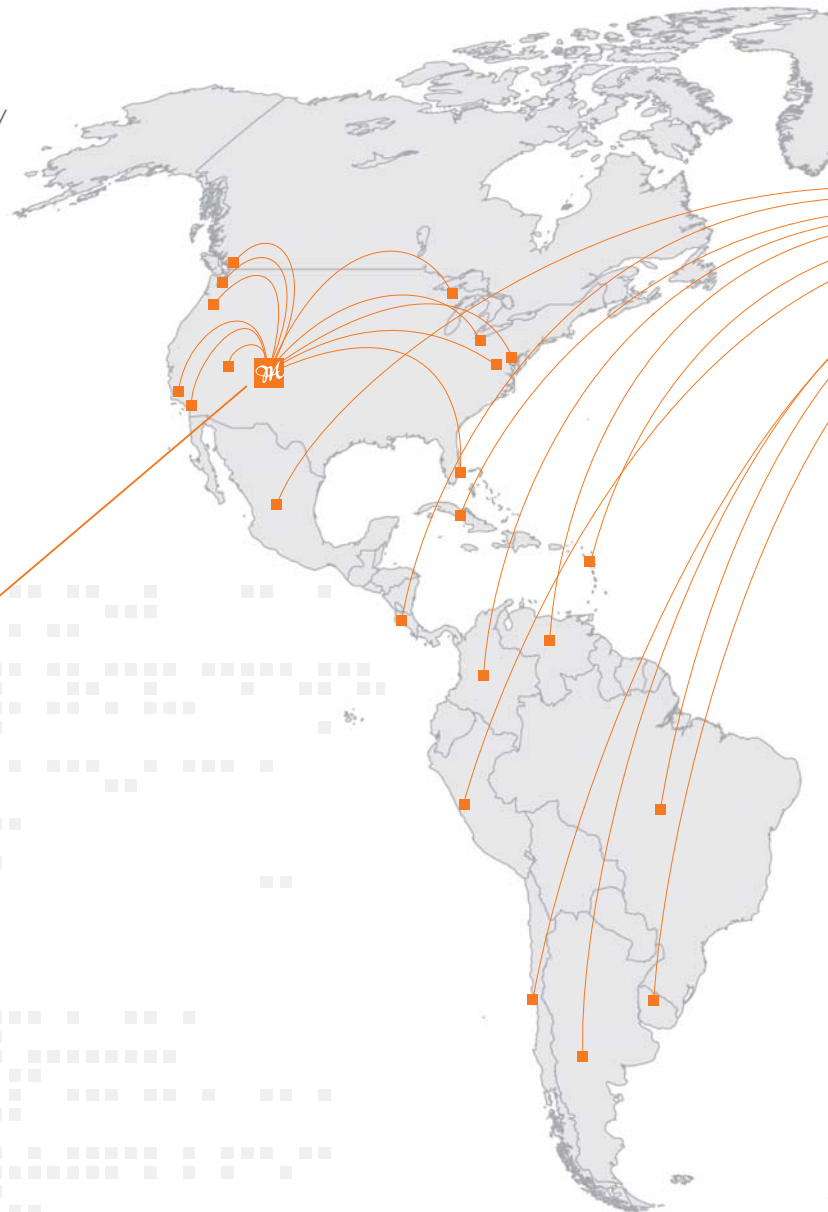

MEISINGER USA



MEISINGER USA Headquarters, Colorado

MEISINGER FRANCE



MEISINGER Headquarters Neuss, Germany

MEISINGER GERMANY (HQ)

(MEISINGER Implants)
(myplant GmbH)

MEISINGER ASIA

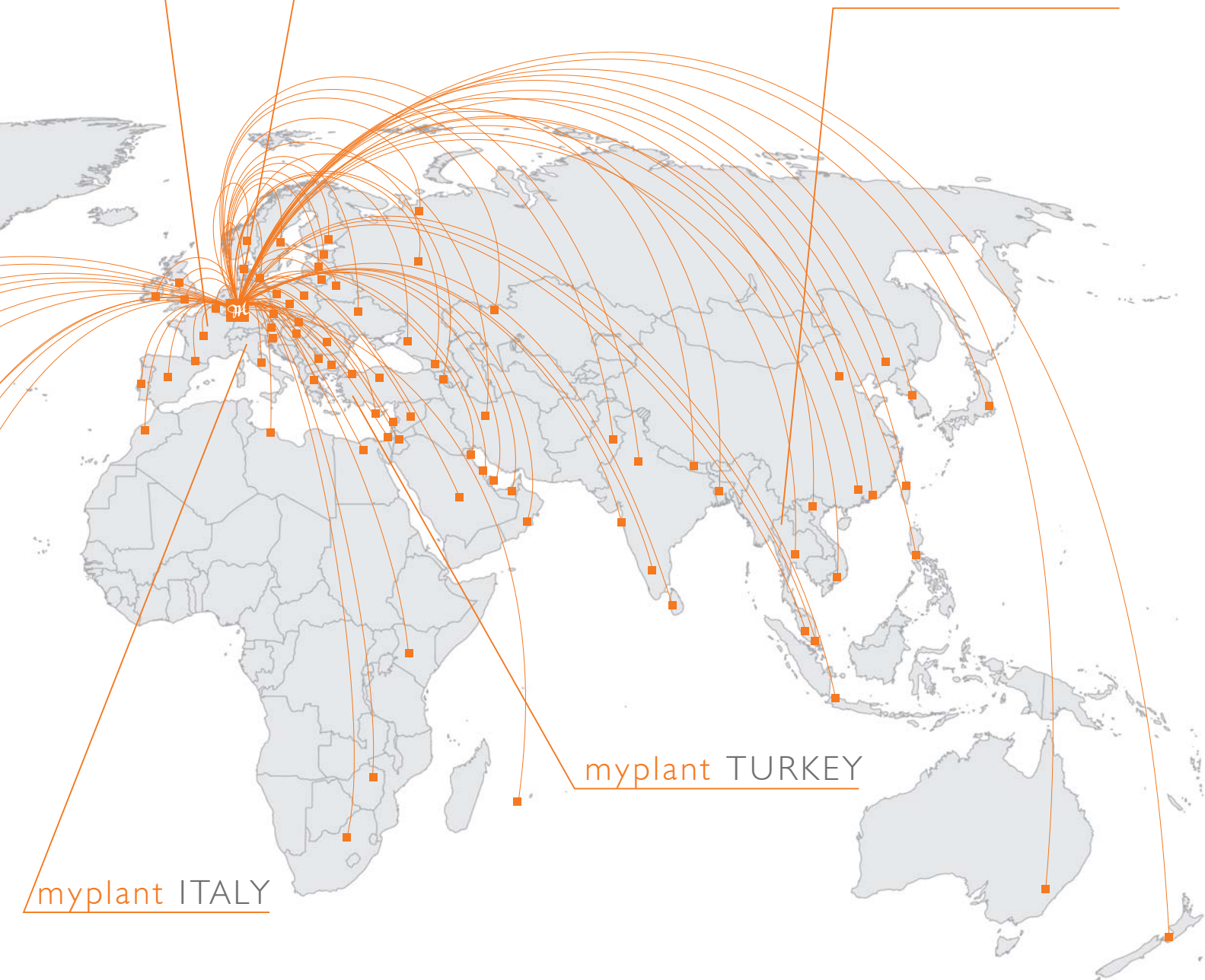

myplant ITALY

myplant TURKEY

OKTAGON®

Closing the gap!

TEST THE PROVEN DESIGN NOW IN Ø 3.75



Ø 3.3



Ø 3.75



Ø 4.1

Ask for the
corresponding
set of
instruments



Additionally available as
Bone Level Tapered & Tissue Level



CONTENT

TRAINING & EDUCATION MODELS

- 10 Individual display models
- 11 Large format models
- 12 Training models
- 13 Full anatomical display models

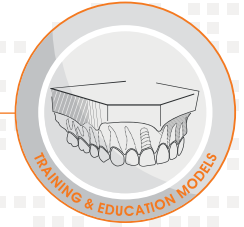

DIGITAL CHAIRSIDE SOLUTION (DCS)

- 15-16 MEISINGER DCS Scan
- 15 Solutions for digital data processing
- 17-18 MEISINGER DCS Pro4 & Pro5
- 19 Product overview

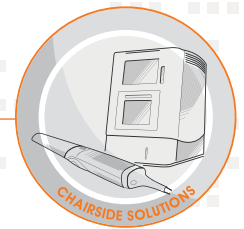

GUIDED SURGERY & GUIDED BONE MANAGEMENT®

- 20 Planning service
- 21-22 Order process and timeline
- 23-27 Guided surgery
- 28-32 Guided Bone Management®
- 29 Benex®-Control
- 29 Bone spreading
- 30 Urban Master-Line
- 31 Khoury-Line
- 32 Sinus lift



CUSTOMIZED PROSTHETICS

- 33-35 Products and services overview



TRAINING & EDUCATION MODELS



MEISINGER DIGITAL offers you a unique variety of tooth, jaw and implant models. The possible applications are as diverse as the colors, material properties and shapes. The following pages will give you an overview of our most important model categories.

INDIVIDUAL DISPLAY MODELS

For many patients it is very helpful and of great interest to be able to see the goal of the upcoming operation prior to a implantological procedure.

MEISINGER DIGITAL provides transparent 1:1 display models to help you visualize your treatment concept. The models can be selected from a range of pre-defined restorations or assembled individually as desired.

The high-quality display models are then designed and manufactured by our technicians with the utmost precision and care according to your specifications - and optionally with your own logo. You are welcome to request a demo model for a limited time without obligation. Convince yourself of the high quality and informative character of our display models!

HIGHLIGHTS

- Detailed 1:1 scale jaw model
- Ideal for patient education and surgical planning
- Guaranteed not to yellow
- Coordinated surface properties to enhance the overall impression

Figure number	Description
MDIM01	Individual display model - 1 crown
MDIM02	Individual display model - 1 three-unit bridge
MDIM03	Individual display model - 1 crown and 1 three-unit bridge
MDIM04	Fully individual display model – free in design incl. own logo

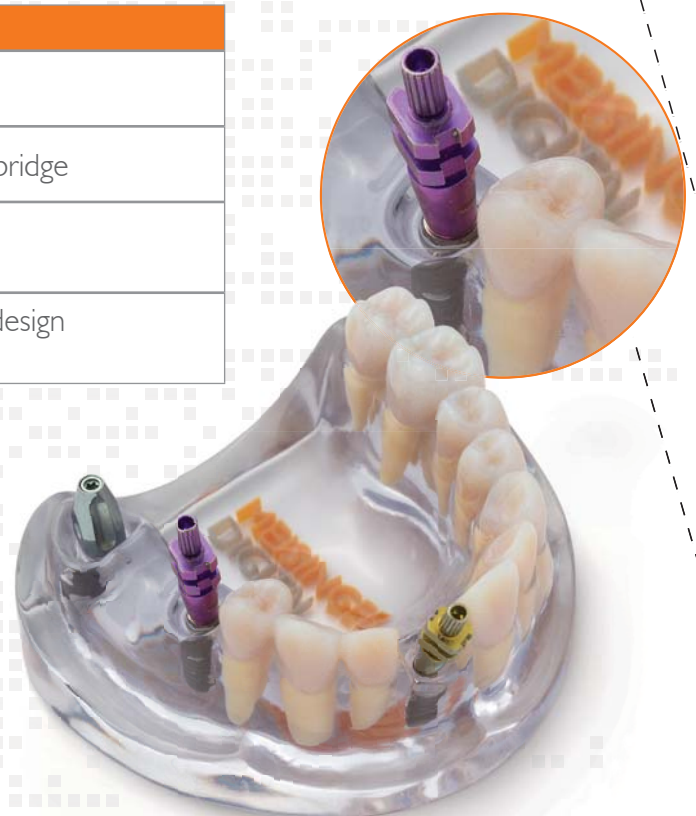

LARGE FORMAT MODELS

Looking for an eye-catcher for your practice? Then put your preferred implant system in the spotlight! With MEISINGER DIGITAL, implants can now make it big. Our large-format models are displayed in a 10:1 ratio as standard and are offered in all variants (BL/TL/BLT) of our OKTAGON[®] implant line (MEISINGER Implants).

Due to the enlarged dimensions, the advantages and features of the implants can be clearly explained.

- HIGHLIGHTS**
- Large format models of common implants for in-practice viewing
 - 10:1 scale
 - Individual color selection

Figure number	Description
MDIMO	Large format model at 10:1 scale (BL/TL/BLT)



We can also present any other implant as a model. If you have a request for a customized implant model, please send us an e-mail with the corresponding data set to digital@meisinger.de or call us on 02131 2012-303.

We will then check as soon as possible whether we can produce your request and will be happy to provide you with an individual quote.



TRAINING MODELS

To support dental education and training, MEISINGER DIGITAL offers innovative 3D training models. After intensive development work, we provide prospective students and experienced doctors with lifelike dental models that uniquely reproduce natural teeth in terms of shape, color and hardness. In this way our training models enable you to get a good understanding of the differences in the processing of the biological materials as well as varying anatomical conditions.

With the help of these dental training models, it is possible to simulate a wide range of dental indications and to improve one's own skills, for example in tooth preparation. The dental models are recorded in a specially developed customizable jaw model. Thanks to the tooth-holding mechanism developed by MEISINGER DIGITAL, it is quick and easy to replace treated tooth models with new ones.

HIGHLIGHTS

- True-to-nature design of natural structures including pathologies with maximum freedom in training model design
- Adjustable hardness in selected model areas
- Ideal for training and education purpose in dentistry
- Innovative tooth retention mechanism for quick and easy replacement of individual teeth

Figure number	Description
MDTM01	Indication-based training model

On request, we can adapt existing models for your specific training goals or develop a customized solution from scratch in close cooperation with you. The indications are virtually unlimited!

Send us an e-mail with the corresponding data set to digital@meisinger.de or call us on 02131 2012-303. We will then check your request as quickly as possible and will gladly provide you with an individual quote.

FULL ANATOMICAL DISPLAY MODELS

Thanks to the application of transparent materials, the full anatomical display models make it possible to depict the internal anatomy of the mandible in great detail. In combination with the surgical guide selected for the corresponding indication, treatment options can be clearly displayed and explained to the patient.

Figure number	Description
MDAM01	Full anatomical display model

HIGHLIGHTS

- Full anatomical display models including complex, internal anatomical structures visible thanks to the use of transparent materials
- Case-specific customization made possible with additive manufacturing
- Ideal for surgical planning and patient education and information

At the customer's request, we adapt existing models for your specific needs or develop a completely new customized solution in cooperation with you.

Send us an e-mail with the corresponding data set to digital@meisinger.de or call us on 02131 2012-303. We will then process your request as quickly as possible and will gladly provide you with an individual quote.



DIGITAL CHAIRSIDE SOLUTIONS (DCS)



Discover the digital products and services from MEISINGER DIGITAL in the CAD/CAM field! With Digital Chairside Solutions (DCS) we offer you a complete chairside package for all types of prosthetic restorations, giving you maximum freedom in terms of indications and material selection.

Take advantage of our high-end digital technology options for your practice: From the intraoral scanner, which delivers outstanding results comparable to the market-leading systems, to the exocad chairside CAD software, which creates the perfect design in just a few steps and transfers it fully automatically to the DCS milling machine for the fabrication of the prosthetics. In close cooperation with imes-icore® our milling machines MEISINGER DCS Pro4 & DCS Pro5 offer the highest flexibility and an unlimited choice of application possibilities due to their unique open design.



Chairside solution in your dental office/
external manufacturing by MEISINGER DIGITAL

MEISINGER DCS SCAN

MEISINGER DCS Scan provides an extremely efficient digital scan of the patient situation and is comparable to current state-of-the-art scanners. Our scanner is open for the export of scan files in all known formats and can be seamlessly integrated into CAD software, making it predestined for use in the chairside workflow. With the 22 mm depth sensor, even subgingival preparations can be easily scanned, and with the help of artificial intelligence, it is no longer necessary to manually cut out scan areas.

HIGHLIGHTS

- Intraoral scanner with premium performance
- High speed (upper/lower jaw in 40 sec.)
- Powerful artificial intelligence (With a large 16x12 mm field of view at a scan depth of 22 mm)
- Identifies and filters unnecessary data from the soft tissue automatically
- Very attractive price/performance ratio

Automatic anti-fogging

Autoclavable (up to 100 times)

Motion controlled operation mode at the touch of a button

Ergonomically designed and very handy

Lightweight: 240 g

Dynamic LED indicator

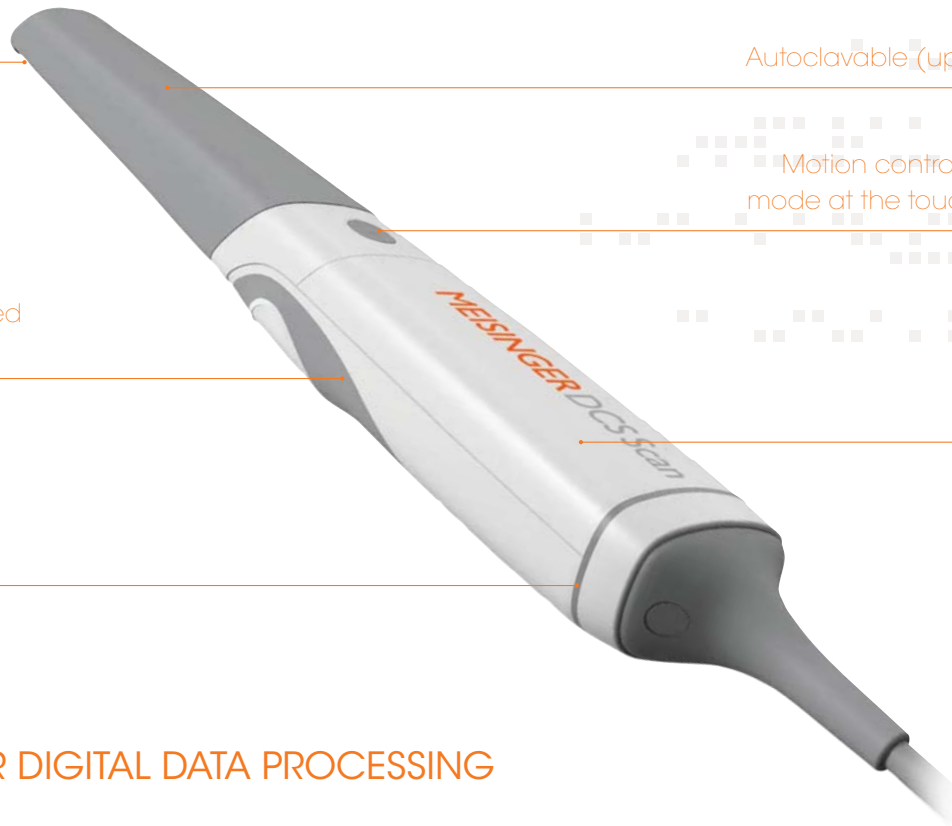

SOLUTIONS FOR DIGITAL DATA PROCESSING



Facts

- Easy CAD design with exocad Chairside CAD, which enables you to achieve the final design in just a few clicks
- Optimal CAD software for use in the clinical environment thanks to automation and an adapted workflow
- Powerful computing unit for efficient data processing

BATTLECARD



Criteria / Manufacturer	Trios 3-5	Medit i700/wireless	Dexis Carestream CS 3800	iTero Element 3D Plus	Ceres Primescan AC	MEISINGER DCS Scan
Autoclavable tips	Yes	Yes	Yes, three sizes	Yes	Yes	Yes, two sizes
Wireless	Yes • Also wired version available!	Medit i700: No Medit i700 wireless: Yes	Yes • Also wired version available!	No	Yes	No
Weight	Trios 3,4: 380 g Trios 5: 299 g incl. battery	Medit i700: 245 g Medit i700 wireless: 345 g	240 g	470 g	457 g Plastics 524 g Metal case	240 g
Color scan	✓	✓	✓	✓	✓	✓
Software update	Covered by annual license fee	Free of charge	-	3 years in purchase price included	Various	Free of charge
Output format	Open system, file export in STL + PLY format or 3Shape Workflow	Open system, file export in STL, PLY and OBJ format	Open system, file export in STL, PLY, OBJ and Xorder format	Open system, file export in STL + PLY format	File export in STL format	Open system, file export in STL, PLY and OBJ format
Included Software & Tools	<ul style="list-style-type: none"> • Patient Monitoring • Patient Specific Motion • Smile Design • Treatment Simulator • Impression Scan 	<ul style="list-style-type: none"> • Medit Smile Design • Medit Ortho Simulator • Medit Crown Fit • Impression Scan 	<ul style="list-style-type: none"> • CS ScanFlow Premium (chargeable) • Dentureless workflow • MP4-format • HD-3D-impressions 	<ul style="list-style-type: none"> • Patient Monitoring • TimeLapse Technology • Patient Specific Motion • Treatment/Outcome Simulation • Occlusogram 	Depending on software version <ul style="list-style-type: none"> • Restoration + STL • Aligner, Sure Smile, • Full jaw monitoring • Smile Design • Treatment simulation 	<ul style="list-style-type: none"> • Model Design • Jaw motion simulation • Undercut control • Bite control • Direct export to exocad Coming soon: <ul style="list-style-type: none"> • Ortho simulation • Oral Health Care Cavity detection
Special features	Trios 3-5: <ul style="list-style-type: none"> • AI Scan technology • Remote control mode in handle ONLY Trios 4,5: <ul style="list-style-type: none"> • Fast heat up • Surface cavities • Swivel head ONLY Trios 5: <ul style="list-style-type: none"> • Calibration-free scanning • Sensory indication during scanning • Improved ergonomics • Effortless scanning • Hygienic concept 	<ul style="list-style-type: none"> • 3D-in-motion Video technology (Combination of digital scan and impression) • Two high speed cameras • Texture Scan • Scanmatch • Overlay of an impression scan • Swivel head ONLY Medit i700 wireless: <ul style="list-style-type: none"> • Video-based scanning for high resolution images • 2x Superfast for faster scanning • Remote control mode in handle 	<ul style="list-style-type: none"> • Calibration-free scanning • Anti-fogging due to minimal air flow • Remote control mode in handle • Impression Scan • Porsche design • Own WAV-file playable 	<ul style="list-style-type: none"> • Surface cavities • Visualization of tooth erosion + malocclusion • Remote control mode in handle • Set preparation 	<ul style="list-style-type: none"> • Improved ergonomics • Effortless scanning • Hygienic concept • AI Scantechnology • Fast heat up • Surface cavities • Remote control mode in handle 	<ul style="list-style-type: none"> • Improved ergonomics • Effortless scanning • AI scan eliminates erroneously scanned soft tissue • Hygienic concept • Fast heat up • Remote control mode in handle • Motion sensing • Own WAV-file playable
Scan area	16 x 17 mm, depth 16 mm	ONLY Medit i700 wireless: 14 x 13 mm, depth 17 mm	16 x 14 mm, depth 21 mm	18 x 14 mm, depth 15 mm	16 x 16 mm, depth 20 mm	16 x 12 mm, depth 22 mm
Disinfection	Tips sterilizable ONLY Trios 5: Protective foil	UV-C LED air disinfection Tips sterilizable	Tips sterilizable	Tips sterilizable	Tips sterilizable, special autoclavable sleeve	Tips sterilizable 100 runs
Way of function	<ul style="list-style-type: none"> • Ultrafast Optical Sectioning™ technology • confocal principle • video • Real-time 3D-image-overlay 	<ul style="list-style-type: none"> • 3D-in-motion video technology • Triangulation method 	<ul style="list-style-type: none"> • Real-time 3D-image-overlay 	<ul style="list-style-type: none"> • Sectioning-Scan-Visualization with 3D Lifelike Model • Real-time 3D-image-overlay 	<ul style="list-style-type: none"> • Smart Pixel Sensor Technology • confocal principle • video • Real-time 3D-image-overlay 	<ul style="list-style-type: none"> • Motion sensing
Connections to the laboratory	Trios Communicate	<ul style="list-style-type: none"> • Medit Link • Data exchange via integrated cloud solution 	Open for individual data transmission	Open for individual data transmission	Cerec Connect Case Center – software for data transmission	<ul style="list-style-type: none"> • Open individual data transmission • Order Tracking
Cart versions	Laptop/Move	Laptop/Cart	Optionally available, Scan Cart	Laptop + Cart	Only Cart	Laptop + Cart

MEISINGER DCS PRO4 & PRO5

The milling machines MEISINGER DCS Pro4 and DCS Pro5 leave nothing to be desired: The machines support wet milling and – just like the CEREC® MC XL or CEREC® Primemill – dry milling.

The DCS Pro4 and DCS Pro5 can be regarded as high-end milling machines in the chairside area. The 4- or 5-axis milling technology and the wide variety of compatible holders offer an unlimited range of possibilities.

Together with imes-icore®, we are the first manufacturer to develop a fully integrated, open system that can be easily combined with products from other brands as well as all common intraoral scanners.

HIGHLIGHTS

- 4- or 5-axis milling
- Machining of any material (including titanium)
- Easy to handle and operate
- Wet and dry machining possible
- Fully autonomous operation mode due to integrated compressed air and cooling liquid
- High precision due to integrated temperature compensation
- Machining of all common material blocks and blanks
- No external PC required
- Automatic calibration
- Automatic cleaning function

4-axis
machine



5-axis
machine



POWERED BY
imes-icore®
Dental & Medical Solutions

BATTLECARD



PRIMEMILL



MEISINGER DCS Pro4
powered by imes-icore



MEISINGER DCS Pro5
powered by imes-icore

Criteria / Manufacturer	Dentsply Sirona	MEISINGER DIGITAL	MEISINGER DIGITAL
System type	Closed system	Open system	Open system
Number of Axes	4	4	5
Processing mode	Wet & Dry	Wet & Dry	Wet & Dry
Spindle	Double spindle, 50,000 rpm	High frequency spindle, 100,000 rpm	High frequency spindle, 100,000 rpm
Tool management	4 tools, No tool changer	6 tools, Automatic smart tool changer	10 tools, Automatic smart tool changer
Dimensions	729 x 465 x 454 mm	422 x 556 x 644 mm	422 x 556 x 644 mm
Operating speed	5 minutes	8 minutes	8 minutes
Self cleaning function	✓	✓	✓
Suction unit	Mandatory for dry milling	Not required	Mandatory for zirconia milling
Compressed air	0.7 - 1.06 bar, external compressed air required	No external compressed air required	No external compressed air required
Holder	<ul style="list-style-type: none"> • Single holder for blocks 	<ul style="list-style-type: none"> • Single holder for blocks and Pre-Milled abutments 	<ul style="list-style-type: none"> • Single holder for blocks and Pre-Milled abutments • 6-fold block adapter • Round blank holder 98 mm • C-Clamp-Holder 98 mm* • 6-fold Pre-Milled abutment*
Blanks	-	-	✓
Interior lighting	✓	✓	✓
Complete implant milling**	-	✓	✓
Milling materials	<ul style="list-style-type: none"> • Pre-sintered ZrO₂ • Glass ceramics • Lithium disilicate • Lithium silicate • Hybrid ceramics • Composite • PMMA 	<ul style="list-style-type: none"> • Dense sintered ZrO₂ • Pre-sintered ZrO₂ • Pre-Milled Abutment (Ti) • Pre-Milled Abutment (CoCr) <ul style="list-style-type: none"> • PMMA/PEEK • Glass ceramics • Lithium disilicate • Lithium silicate • Hybrid ceramics • Composite 	<ul style="list-style-type: none"> • Dense sintered ZrO₂ • Pre-sintered ZrO₂ • Pre-Milled Abutment (Ti) • Pre-Milled Abutment (CoCr) <ul style="list-style-type: none"> • PMMA/PEEK • Glass ceramics • Lithium disilicate • Lithium silicate • Hybrid ceramics • Composite
Restoration type	<ul style="list-style-type: none"> • Crown • Bridge • Inlay, Onlay, Veneer 	<ul style="list-style-type: none"> • Crown • Bridge • Inlay, Onlay, Veneer • Hybrid-Abutment • Pre-Milled Abutment 	<ul style="list-style-type: none"> • Crown • Bridge • Inlay, Onlay, Veneer • Hybrid-Abutment • Aligner • Full denture • Model • Drilling guide • Model cast prosthesis • Telescopic technique • Abutment
Noise level	High	Low	Low
Display	7" HD Touchscreen	10"1" HD Touchscreen	10"1" HD Touchscreen
Internal PC	✓	✓	✓
Automatic machine calibration	✓	✓	✓
Digital full denture	-	-	✓
LED light strip	✓	✓	✓
Warranty	1 year	1 year (in progress for 2 years)	1 year (in progress for 2 years)

* Additional equipment
** Various materials

DCS PRODUCTS AND SERVICES AT A GLANCE!

Figure number	Description
Scanner	
MDCSS	MEISINGER DCS Scan
CITIS	CORITEC ione scan
Scanner equipment	
DCST1	DCS Scan Tip
DCTM1	DCS Scan Tip Mini
CSL01	Cart for Scanner and Laptop
Computer	
HEP01	CAD/CAM HighEnd PC
HEL01	CAD/CAM HighEnd Laptop
Software	
SWIC4	iCAM DCS Pro4
SWIC5	iCAM DCS Pro5
SWEC4	exocad ChairsideCAD Software package MEISINGER DCS Pro4 (CAD+CAM)
SWEC5	exocad ChairsideCAD Software package MEISINGER DCS Pro5 (CAD+CAM)
SWECB	exocad ChairsideCAD Basic version
SWECA	exocad ChairsideCAD Virtual Articulator Module
SWECM	exocad ChairsideCAD Model Creator
SWECI	exocad ChairsideCAD Implant Module
SWECS	exocad ChairsideCAD Therapeutic aligner module
SWECK	exocad ChairsideCAD Ultimate Bundle
Milling machines	
MDCS4	MEISINGER DCS Pro4
MDCS5	MEISINGER DCS Pro5
Milling machine equipment	
MDVAC	iVAC silent
DESK1	Machine desk T0 (W x H x D 422 x 900 x 540 mm)
Starter kits milling machine	
MPSK1	Starter kit Medentika Pre-Milled Abutments with 6 Abutments
SKP04	Starter kit DCS Pro4 (milling tools, measuring cup, cooling lubricant, collet, calibration tool, auto-calibration kit, manuals)
SKP41	Starter kit DCS Pro4 complete (milling tools, measuring cup, cooling lubricant, collet, calibration tool, material, auto-calibration kit, manuals)
SKP05	Starter kit DCS Pro5 (milling tools, measuring cup, cooling lubricant, collet, calibration tool, auto-calibration kit, manuals)
SKP51	Starter kit DCS Pro5 complete (milling tools, measuring cup, cooling lubricant, collet, calibration tool, material, auto-calibration kit, manuals)

GUIDED SURGERY & GUIDED BONE MANAGEMENT®



PLANNING SERVICE

The future is digital! This also applies to implantology and dental surgery. MEISINGER DIGITAL supports you with highly specialized expertise in surgical planning and the manufacture of high-quality surgical guides to make your treatments more effective and safer. Based on your scan data, we create individual solutions for your patients. As a result, you benefit from our experience and increased predictability of results, helping you to sustainably increase the efficiency of your practice. Choose the service that best suits your needs from our modular range of services. If you wish, we can take over the entire planning process as well as the production of the guide.

Our service packages include the following components, which you can flexibly select according to your needs:

- FULL SERVICE** - Complete planning, design and printing of the surgical guide
- DIGITAL SERVICE** - Implant planning and digital surgical guide design
- SUPPORT ME** - Design and printing of the surgical guide, fixation of the drill sleeves on request
- ONLY PRINT** - Printing of the surgical guide, fixation of the drill sleeves on request

ORDER PROCESS AND TIMELINE

With MEISINGER DIGITAL, you have a competent team of dental technicians at your side to support you in your specific patient cases. The following schedule for the fabrication of a surgical guide can be integrated into your treatment plan. It is important that you provide us with all necessary data, models and order information to ensure a quick turnaround.

After the initial contact, you will receive the login and password to access our server.

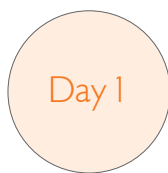

On our secure (GDPR compliant) server you will find a folder where you can upload your .stl and .dcm datasets. Any queries regarding the order will be posed by us on the same day before 4pm.



As soon as MEISINGER DIGITAL has completed the planning proposal, we will contact you and deliver it as a PDF or – if the software is available on your side – via the cloud in the required format for your approval.

Approval of the design by the dentist by digital signature on the server



Design and printing of the template, Incorporation of drill sleeves



Dispatch of the surgical guide and the corresponding Pilot-Stop-Drills as well as the surgical drilling protocol

CHECKLIST

✓ Specifications for the radiologist:

- Remove all non-fixed metal parts from the patient's mouth
- The opposing jaw should be blocked with a wooden spatula or a non-radioopaque material to a maximum of 2 mm.
- Lips and cheeks should be separated from the gingiva with cotton rolls, especially in the case of edentulism
- Tongue should not be touching the palate

Recommended layer spacing:

- 0.2 mm - 0.5 mm

General instructions to the patient during admission:

- Do not move, do not swallow, do not breathe

Data export:

- DICOM III format, no raw data
- No separate viewer required

✓ Specifications for optical scanning:

- Always send scan data as .stl file
- Avoid artifacts/double projections (crop scan/rescan)
- The first scan should reflect the actual situation in the mouth (on which the guide will be fabricated)
- A second scan with prosthetic planning (also with existing denture) is helpful for future prosthetic planning
- If possible, the scan data should not include any holes

- For free-end situations and larger gaps, especially in the anterior region, please also include a scan of the opposing jaw and a scan of the bite registration
- In the maxilla, for larger implant restorations, scan the entire palate
- In the mandible, for larger restorations, scan as much of the mucosa as possible

✓ Specifications for models:

- A model that reflects the actual situation in the mouth is needed (the template will be made on this model)
- A model with prosthetic planning (including existing dentures) is helpful for future prosthetic planning

- For free-end situations and larger interdental gaps, especially in the anterior region, please also send a model of the opposing jaw and a bite registration if necessary
- If possible, please send trimmed models

Documents for edentulous patients:

For the x-ray:

For radiographs, either an x-ray template should be used or the mucosal parts in the crease should be separated with cotton rolls to make them visible on the x-ray.

Model documents:

A current impression/model/scan of the edentulous situation in the mouth is needed. Another impression/model/scan of the denture in the mouth, including the vestibulum around the denture if possible.

Alternatively, a duplicate of the prosthesis as plastic mold or a silicone impression which covers the complete prosthetic can be used.

If the correct model documents are available, we can guarantee you a planning that is also prosthetically individualized for your patient. For edentulous patients, especially in the mandible, it is advisable to design the drill guide for direct contact with the jawbone. This will provide you with more stability when positioning the guide in the mouth. Alternatively, fixation pins may be used.

GUIDED SURGERY



PILOT-STOP-DRILLS – PARTIALLY GUIDED IMPLANTOLOGY

The new MEISINGER Pilot-Stop-Drills are used for guided pilot drilling at the beginning of implant placement. The integrated depth stop in combination with the appropriate drill sleeve allows easy and safe preparation of the jaw for the placement of an implant at the desired depth.

In combination with the Pilot-Stop-Drills, MEISINGER DIGITAL offers a surgical guide planning service based on your data. Both the planning service and the Pilot-Stop-Drills can be applied independently from the implant system.

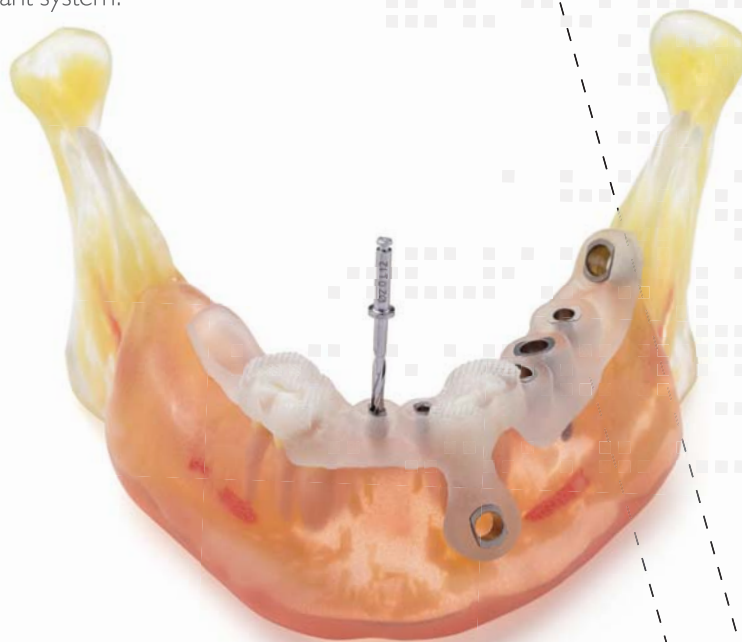







	Figure number	Shank	Working part Ø in mm	Working part length in mm *	Cutting length in mm **
	PSD06	RA	020	14	6
	PSD08	RA	020	16	8
	PSD10	RA	020	18	10
	PSD12	RA	020	20	12
	PSD14	RA	020	22	14
	Figure number	Outer Ø in mm	Inner Ø in mm	Length in mm	
	HNS04	032	020	4	

*The length of the working part represents the length of the instrument before the stop.

**The cutting length represents the length of the drill that effectively cuts the bone.

HOW TO USE THE PILOT STOP DRILLS

EXEMPLARY PLANNING SCENARIO

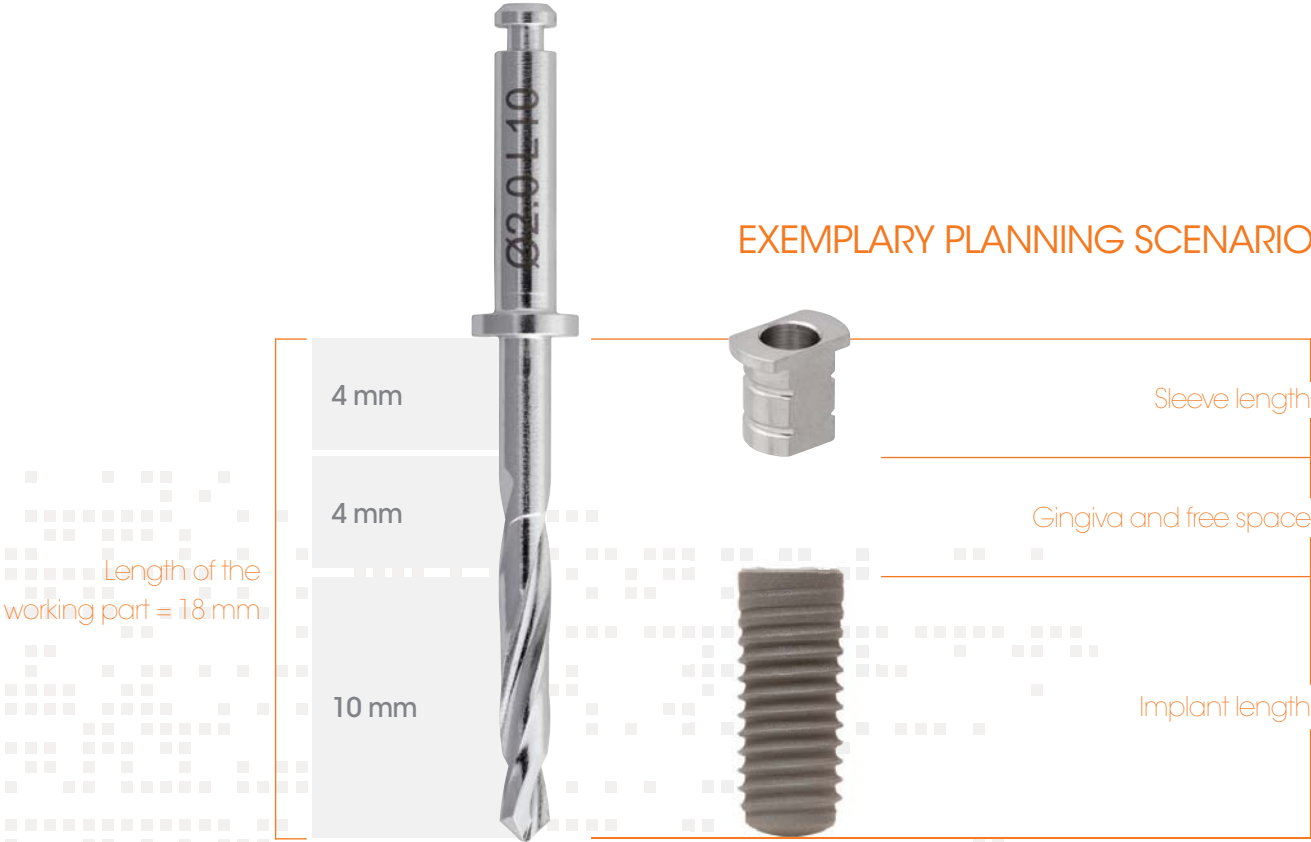

The depth of the pilot hole in the jaw bone results from the length of the working part (in this case 18 mm) minus the sleeve length and the thickness of gingiva and (optional) free space (in this case 4 mm in total). Note: Since our our Pilot-Stop-Drills are available in different lengths and the free space between gingiva and sleeve can be minimized during the planning, we ensure that the shortest possible drill can be used. Thus, the patient can open the mouth less and experiences the greatest possible comfort.

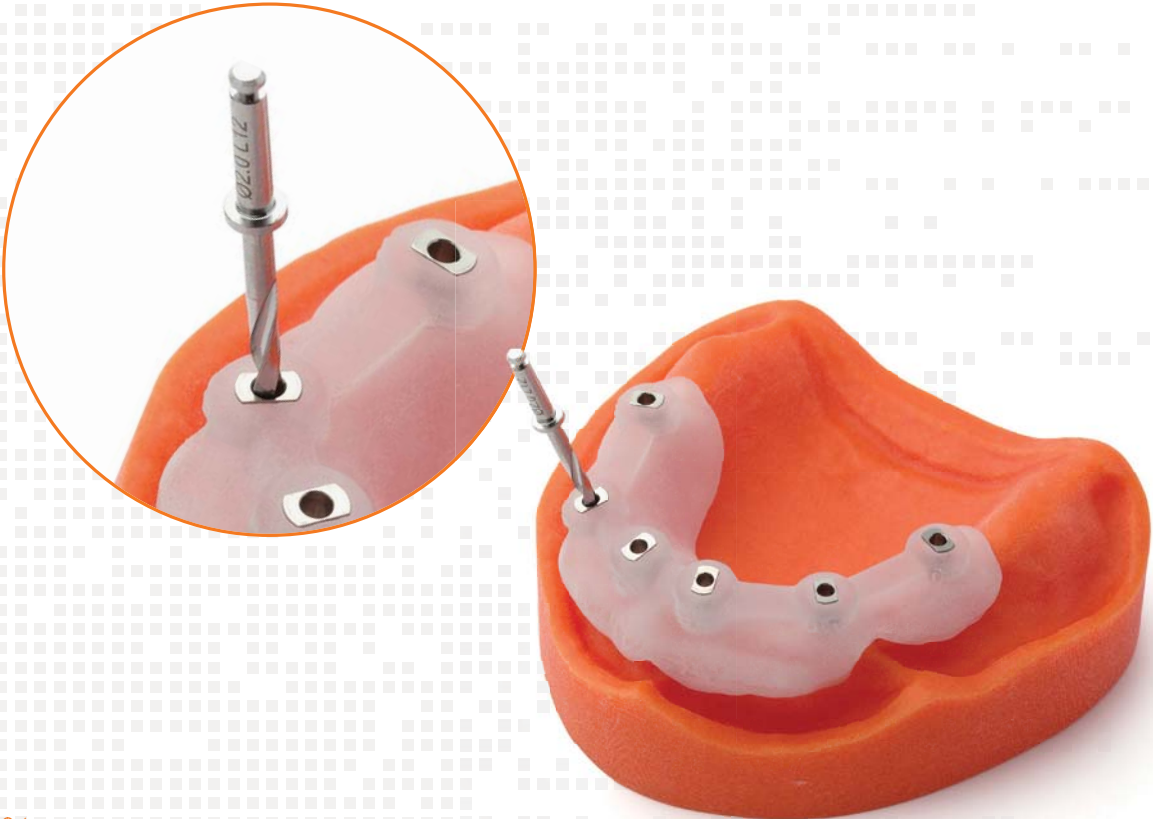

SERVICES

IMPLANT PLANNING

PACKAGE	Services MEISINGER DIGITAL	Action CUSTOMER	Compatibility
FULL SERVICE	Model scan Data import Data matching Implant planning Design of the surgical guide Printing of the surgical guide Bonding of drill sleeves (incl. sleeves)	Data and/or model shipping	OKTAGON® & myplant
			External systems
DIGITAL SERVICE	Data import Data matching Implant planning Design of the surgical guide	Data and/or model shipping Printing of the surgical guide Bonding of drill sleeves	OKTAGON® & myplant
			External systems
SUPPORT ME	Design of the surgical guide Printing of the surgical guide Bonding of drill sleeves plus additional charge for sleeves	coDiagnostix / Exoplan Simplant / Magellan license Data import Data matching Implant planning	OKTAGON® & myplant
			External systems
ONLY PRINT	Printing of the surgical guide Bonding of drill sleeves plus additional charge for sleeves	Simplant / Exoplan license Data import Data matching Implant planning Design of the surgical guide	OKTAGON® & myplant
			External systems

COMPATIBILITY

The MEISINGER DIGITAL pilot guide can be used in combination with most implant systems available on the market. For a wide range of implant connections, we also offer a fully guided variant to ensure that each instrument is guided during the procedure.

Implant MANUFACTURER	Implant CONNECTION	FULL GUIDE	PILOT GUIDE
MEISINGER Implants	OKTAGON® BONE LEVEL NC 3.3	-	✓
	OKTAGON® BONE LEVEL NC 3.75	-	✓
	OKTAGON® BONE LEVEL RC 4.1	-	✓
	OKTAGON® BONE LEVEL RC 4.8	-	✓
	OKTAGON® TISSUE LEVEL RP 3.3	-	✓
	OKTAGON® TISSUE LEVEL RP 3.75	-	✓
	OKTAGON® TISSUE LEVEL RP 4.1	-	✓
	OKTAGON® TISSUE LEVEL RP 4.8	-	✓
	OKTAGON® TISSUE LEVEL WP 4.8	-	✓
myplant GmbH	myplant two 3.5 mm	-	✓
	myplant two 4.0 mm	-	✓
	myplant two 4.5 mm	-	✓
	myplant bio 3.5 mm	-	✓
	myplant bio 4.0 mm	-	✓
	myplant bio 4.5 mm	-	✓
Dentsply Sirona	Astra Tech Implant / PrimeTaper EV 3.0	-	✓
	Astra Tech Implant / PrimeTaper EV 3.6	✓	✓
	Astra Tech Implant / PrimeTaper EV 4.2	✓	✓
	Astra Tech Implant / PrimeTaper EV 4.8	✓	✓
	Astra Tech Implant / PrimeTaper EV 5.4	(✓)	✓
	Astra Tech Implant EV Profile 4.2 Yellow	✓	✓
	Astra Tech Implant EV Profile 4.8 Blue	✓	✓
	OsseoSpeed / OsseoSpeed TX 3.0 – Yellow	-	✓
	OsseoSpeed / OsseoSpeed TX 3.5, 4.0 – Aqua	-	✓
	OsseoSpeed / OsseoSpeed TX 4.5, 5.0 – Lilac	-	✓
	OsseoSpeed TX Profile 4.5, 5.0	-	✓
	Xive S 3.0, 3.4, 3.8	✓	✓
	Xive S 4.5	✓	✓
	Frialit 3.4, 3.8, 4.5, 5.5	-	✓
	Ankylos C / X 3.5	✓	✓
Ankylos C / X 4.5	✓	✓	
Camlog®	CAMLOG® / CONELOG / SCREW-LINE, PROMOTE 3.3	✓	✓
	CAMLOG® / CONELOG / SCREW-LINE, PROMOTE 3.8	✓	✓
	CAMLOG® / CONELOG / SCREW-LINE, PROMOTE 4.3	✓	✓
	CAMLOG® / CONELOG / SCREW-LINE, PROMOTE 5.0	-	✓
Straumann®	Bone Level 3.3 NC	✓	✓
	Bone Level 4.1, 4.8 RC	✓	✓
	Standard / Standard Plus 4.8 RN	✓	✓
	Standard / Standard Plus 4.8 WN	✓	✓

YOUR ADVANTAGES AT A GLANCE!

COMFORT

- Drill guides held by teeth, gingiva and/or bone
- Reliable feedback on the optimal implant position and the choice of the abutment
- Pre-view of the guide design
- MEISINGER DIGITAL planning service



EFFICIENCY

- Enables the multi-optional planning of a treatment plan
- More predictable and shorter surgeries – less visits of the patient, less stress
- Open databases with implants, abutments, fixation screws, sleeves and scanposts
- Happy patients through binding target agreement and achievement



COMMUNICATION

- Helpful communication and visualization tool
- Support of collaboration between surgeons, prosthodontists and lab specialist
 - Laboratory laptop
 - Own license
 - Free viewer



SAFETY

- Bone quality D1 to D4 (in color)
- Reliable planning due to 3D diagnostics
- Predictable and reproducible results
- Distance to teeth and other structures
- Guided drilling plus implant insertion taking anatomical AND prosthetic aspects into account
- Sterilizable material
- Forensic safeguarding



GUIDED BONE MANAGEMENT®



In addition to guided pilot drillings prior to implantation, MEISINGER DIGITAL enables safe and predictable bone augmentation by introducing guide-assisted Bone Management®. In this innovative approach we combine our planning service with our well-known Bone Management® sets in order to guide burs and trephines safely during the surgery.

Greater safety and even more predictable surgical success – the drilling templates from MEISINGER DIGITAL support you in bone-building measures and in the preparation of an optimal implant bed.



If you have a request for a custom-made drill guide, please write us an e-mail with the corresponding data set to digital@meisinger.de or call us on 02131 2012-303. We will review your request as soon as possible and provide you with a personalized quote.

For more information on all the Bone Management® systems shown on the following pages, please refer to the Bone Management® catalog available at www.meisinger.de.

WITH DIGITAL BONE MANAGEMENT® SAFELY SUCCESSFUL

BENEX®-CONTROL

MEISINGER DIGITAL offers you a straightforward planning and manufacturing service for a drilling template that can be used in combination with the Benex®-Control Set. In the case of deep root residues, we contribute to your success with a drilling template for successful pilot drilling and subsequent extraction.

Application video



CBE00



BONE SPREADING

The drilling template for the Crest-Control Set offered by MEISINGER DIGITAL supports you in performing the crestal saw cut to open the alveolar ridge for subsequent widening with the horizontal spreaders included in the kit.

Application video



CCR00

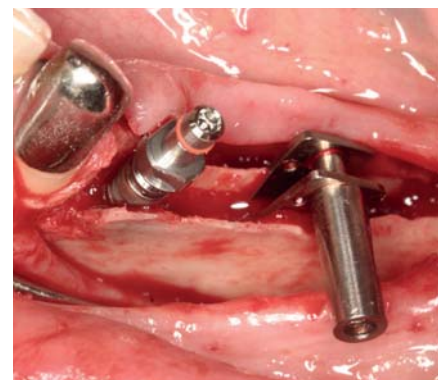

URBAN MASTER-LINE

The worldwide known and successfully applied augmentation techniques according to Prof. Dr. Istvan Urban are now extended by the support of MEISINGER DIGITAL. Use our planning service and our templates, for example, for the safe removal of bone blocks by means of trephines from the Master-Core Sets. In addition, for perfect membrane positioning, we offer you a guide suitable for placing master pins in exactly the right position. Feel free to contact us and become a master in bone augmentation according to Prof. Urban.



Developed by
Prof. Dr. Istvan Urban



BMCPR



KHOURY-LINE

The planning service of MEISINGER DIGITAL also supports you in the augmentation of bone according to the techniques of Prof. Dr. Fouad Khoury. Specific drilling templates can be individually planned for each patient and enable the safe generation of bone cylinders that are required for the carrot technique in combination with our renowned Trepine Ejection System. Additionally, there is also a guide for the Micro Screws available in order to safely fix the bone carrots in a defined position at the defect site.



Developed by
Prof. Dr. Fouad Khoury

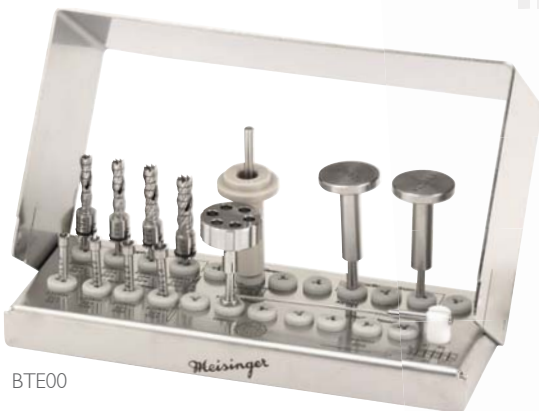

BTE00



Tip!
Also suitable
for root end
resection!

	Figure number	Inner Ø in mm	Outer Ø in mm	Length in mm	Achievable drill hole Ø in mm	Achievable carrot Ø in mm
	231KH	032	043	4	3.1	2.1
	231KH	036	047	4	3.5	2.5
	231KH	040	051	4	3.9	2.9
	231KH	044	055	4	4.3	3.3

SINUS LIFT

Prior to implantation in the maxilla, successful bone augmentation is often a prerequisite for long-term secure placement of the implant. MEISINGER DIGITAL therefore offers surgical guides for common sinus lift techniques. They assist you, for example, in the creation of a precisely located bone window during external opening of the sinus cavity or as a guide for your drills during internal sinus lift. Both types of guides are the perfect complement to our sinus lift sets from the MEISINGER Bone Management® range: External-Lift-Control for external sinus lift and the Crestal-Lift-Control and Internal-Lift-Control sets for internal sinus lift.

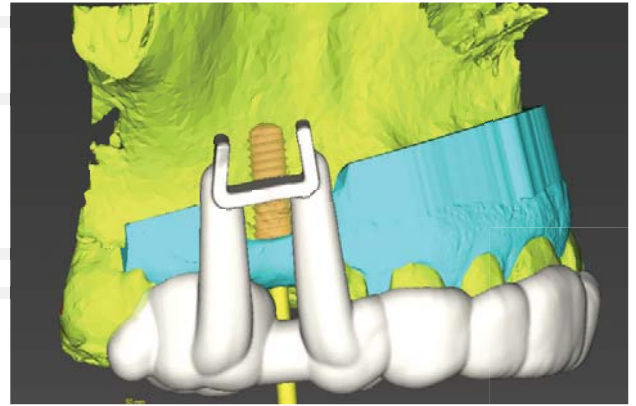
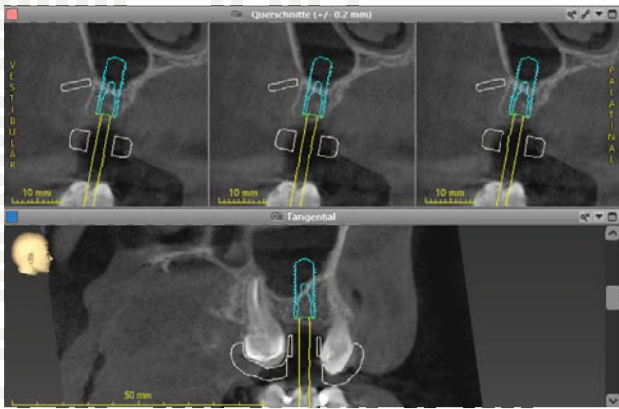

CRESTAL-LIFT-CONTROL



BCL00

EXTERNAL-LIFT-CONTROL



BTL00

CUSTOMIZED PROSTHETICS



Our products in the area of MEISINGER DIGITAL Customized Prosthetics complete the digital workflow with corresponding CAD/CAM components as well as prosthetics, which are planned and produced specifically for each individual patient case.

Choose from MEISINGER DIGITAL's wide range of products the parts and services that ideally match your patient's needs:

- Scanbodies (compatible with OKTAGON®)
- DIM analogs (compatible with OKTAGON®)
- Pre-Milled Blanks (compatible with OKTAGON® and myplant)
- Individually manufactured abutments and gingiva formers
- Individually manufactured prosthetics



CAD/CAM libraries available here

New Ti-Base
for OKTAGON®
coming soon!



PRODUCT AND SERVICE OVERVIEW

Compatibility		Figure number	Description
	Scanbodies		
		11100	Scanbody TL RP CAD/CAM
		11200	Scanbody TL WP CAD/CAM
		11300	Scanbody BL NC CAD/CAM
		11400	Scanbody BL RC CAD/CAM
	DIM Analogs		
		21100	DIM Analog TL RP CAD/CAM
		21200	DIM Analog TL WP CAD/CAM
		21300	DIM Analog BL NC CAD/CAM
		21400	DIM Analog BL RC CAD/CAM
	Pre-Milled Blanks (compatible with Medentika holder)		
		31110	Pre-Milled Blanks Ø 11.5 TL RP
		31210	Pre-Milled Blanks Ø 11.5 TL WP
		31310	Pre-Milled Blanks Ø 11.5 BL NC
		31410	Pre-Milled Blanks Ø 11.5 BL RC
		41110	Pre-Milled Blanks Ø 16 TL RP
		41210	Pre-Milled Blanks Ø 16 TL WP
		41310	Pre-Milled Blanks Ø 16 BL NC
		41410	Pre-Milled Blanks Ø 16 BL RC
			PPMB3
PPMB4			Pre-Milled Blanks Ø 16

Take advantage of our powerful MEISINGER DIGITAL milling center and let our experts create the prosthetic restoration. There are almost no limits when it comes to restorative materials!

MEISINGER DIGITAL designs and produces individual solutions for caps, crowns, inlays, onlays and veneers made of:

- Zircon HAT (VITA colors)
- Zircon multilayer (VITA colors)
- PMMA unpolished/polished (A2; A3; A3.5)
- VITA Suprinity (glass ceramic)
- VITA Mark II (leucite ceramic)
- VITA Tirluxe Multi (leucite ceramic)
- VOCO Grandio (hybrid ceramic)
- Wax
- CoCr

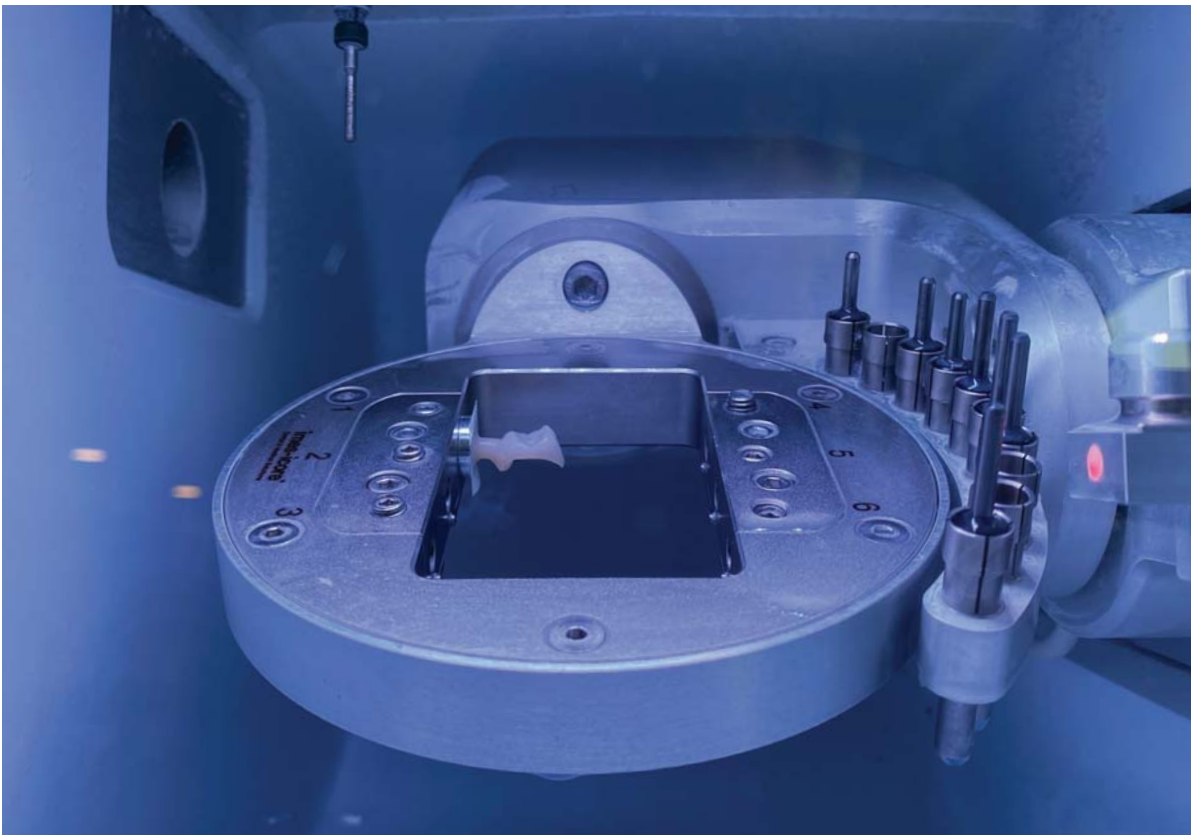

NOTES

A large rectangular area with a thin orange border, containing 25 horizontal lines for writing. The lines are evenly spaced and extend across most of the width of the page. A dashed line is visible on the right side of the page, extending from the bottom towards the top.

NOTES

A large rectangular box with an orange border, containing 24 horizontal lines for writing notes. The lines are evenly spaced and extend across the width of the box. The background of the page features a light gray dotted pattern and two dashed lines that intersect in the upper right corner.

ROTARY SPEED

The following reference values for rotation speeds apply to surgery in general:

ANGLE PIECE (RA):

Optimum: 6,000 - 10,000 rpm

Maximum: 40,000 - 50,000 rpm

Please also observe adapting the rotation speed in relation to the diameter of the instrument as well as the prevailing indication and enough cooling. As a general rule, the larger the working part of an instrument, the lower the speed should be set. Please also pay attention to the special preparation specifications for products made of tool steel.

Please also note the recommended and maximum rotary speeds for the individual instruments on the product packaging and in the corresponding instructions for use.

APPLICATION NOTES



The symbols give merely suggestions for the possible implementation of the products. The user decides and takes full responsibility about the precise deployment according to existing indications. Please follow general application and safety instructions for MEISINGER products in the medical and dental area and also the advice for processing. Details can be found on the internet under en.meisinger.de/services/downloads/ or you can request one by mail.



With the reuse of disposable products the risk of infection cannot be excluded and a risk-free functional safety cannot be guaranteed.



Please follow general application and safety instructions for MEISINGER products in the medical area and also the advice for processing (cleaning, disinfection and sterilisation) of medical devices from Hager & Meisinger GmbH. Please also pay attention to the special preparation specifications for products made of tool steel.

REGULATORY REQUIREMENTS

Meisinger stands for high quality medical devices since 1888. The quality management system of a company which manufactures medical devices must meet specific special requirements. These extremely high requirements are defined in ISO 13485 and meticulously complied with by our company. A MDSAP certificate according to ISO 13485:2016 confirms compliance with the requirements of international authorities in the USA (FDA), Canada (Health Canada), Australia (TGR), Japan (MHLW) and Brazil (ANVISA). All medical devices which you purchase from us as customer, comply with all applicable requirements of the Medical Device Directive 93/42/EEC. Our company is certified by an independent Notified Body and certification is performed according to the specifications of standards. Current certificates can be found on our homepage www.meisinger.de



MANUFACTURER

Hager & Meisinger GmbH
Hansemannstr. 10
41468 Neuss | Germany
Phone: +49 2131 | 2012-0
Fax: +49 2131 | 2012-222
E-Mail: info@meisinger.de
Internet: www.meisinger.de

All rights reserved.

Reproduction, also by extract and reproducing photos, are only permitted with written authorization of Hager & Meisinger GmbH, Neuss.

All offers, orders, and deliveries are subject to Meisinger's "General Sales and Delivery Terms."

We reserve the right to modify our range of products and their design as well as to deviate from the illustrations and data shown.



registered trademarks



Any questions left unanswered?



Sebastian Bolling
Head of MEISINGER DIGITAL
Mobile: +49 151 205 448 45
Fax: +49 2131 2012-222
E-Mail: sebastian.bolling@meisinger.de



Frank Brüggem
Global Digital Manager, Guided Surgery
Mobile: +49 151 145 556 29
Fax: +49 2131 2012-222
E-Mail: frank.brueggen@meisinger.de

