

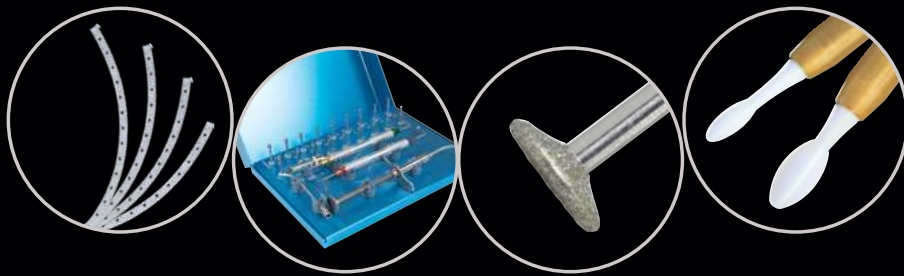

**STRAUSS & CO.**  
Turning Precision Into Value

— **50** —  
years of precision

# 2023 INNOVATIONS



[www.strauss-co.com/innovate](http://www.strauss-co.com/innovate)



## 50 Years of Strauss & Co.



We opened our doors in 1970 as a family run private company and have remained so to this day.

Our products have always spoken for themselves.

The uncompromising quality, meticulous attention to details, our service, flexibility and creativity have provided thousands of unique products and solutions over the years.

Our products are sold in over 70 countries around the world in both the dental field and various industrial fields.

But who are we as a company? What do you really know about us? What makes us special? Watch the video and get to know us a little better...



Orthodontic Products	4 - 9
Surgical Products	10 - 15
Kits	16 - 21
Endodontic Products	22
Ultrasonic Tips	23
Polishing Products	24
Minimal Invasive	25
CAD/CAM	26 - 27
FG Diamond Burs	28 - 29
Accessories	30



SEE DEMO VIDEO

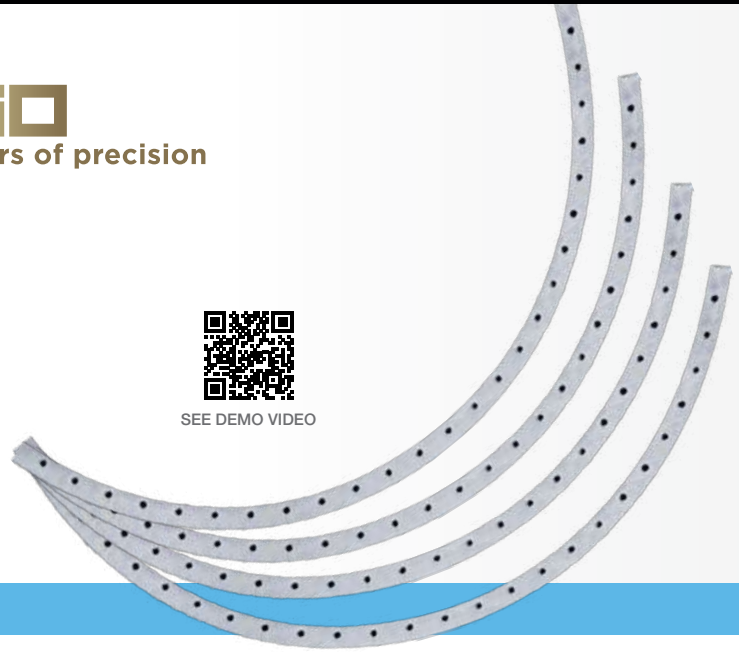

Orthodontic Products

# Lingual Retention Wire Set

Designed by Dr. Yoav mazor  
 MY Smart Orthodontic Products ©

A highly advanced and unique retainer wire, ensuring the best retention at the end of the orthodontic treatment. Can be used for other cases which require a bonded retainer.

**Description:**

- Bio-compatible high grade Nickel Titanium alloy
- Only 017 mm thickness (0.07 inch) – the thinnest existing retainer wire in the market today
- Rectangular cross-cut to ensure better torque retention
- Pre-bended (vertical bend) to prevent wire activation
- Easy to adapt - “dead soft”
- High resistance to breakage
- Unique “clips” for wire stabilization on bonding

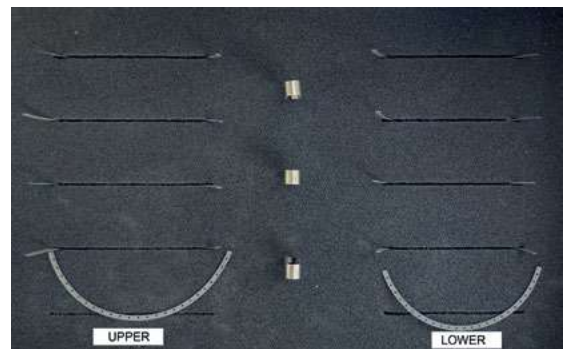

CAT. NO.: RTN.WIRE.KIT1

**The kit contains:**

Photo	Cat. No.	Application	QTY
	RTN.WIRE.UP1	Upper Lingual Retention Wire	5
	RTN.WIRE.LO1	Lower Lingual Retention Wire	5
	RTN.HLD1	Lingual Retention holder	3





Orthodontic Products

## Reciprocal Magic Strips Kit

The new Magic Strips kit is designed for a reciprocal turbine and allows the doctor to connect the strip directly to the dedicated turbine, ensuring faster, accurate, uniform results.

Working according to the thickness of the strips and using the option to curve the strip by manually rotating the head of the strip will give the user complete control over the depth, spacing and angle to provide maximum accuracy.

The kit comes with two strips of any color (0.10, 0.15, 0.20, 0.30) that contain a turbine-fitted tip, a component reinforcement key, a handle (as in the original product) and two double sided strips (0.40, 0.50).

A dedicated adaptor for a non-reciprocal turbine can also be purchased.



Code	MS-RECIP-KIT1	TUR-RECIP1	MOTOR1	MS-ADPT1
Description	Reciprocating Magic Strip Kit 10 strips + 2 handles - variety of grit sizes - single + double side with gap 1 Wrench	Reciprocal turbine hand piece	Low speed motor	Magic Strip Adaptor



Code	MS-DS-050-RFL-5/C	MS-DS-040-RFL-5/C	MS-GAP-RFL-5/C	MS-GAP-RFL-5/M	MS-GAP-RFL-5/F	MS-GAP-RFL-5/SF
Description	Magic Strip Refill KIT - 5 Strips + 1 Handle - 0.5 MM - black - Double Side Pack of 5	Magic Strip Refill KIT - 5 Strips + 1 Handle - 0.4 MM - white - Double Side Pack of 5	Magic Strip Refill KIT - 5 Strips + 1 Handle - Coarse Grit Size - Double Side with gap - Pack of 5	Magic Strip Refill KIT - 5 Strips + 1 Handle - Medium Grit Size - Double Side with gap	Magic Strip Refill KIT - 5 Strips + 1 Handle - Fine Grit Size - Double Side with gap	Magic Strip Refill KIT - 5 Strips + 1 Handle - Super Fine Grit Size - Double Side with gap
Thickness (mm)	0.50	0.40	0.30	0.21	0.15	0.11



Orthodontic Products

# Orthodontic Pro kit

The Strauss & Co Orthodontic Pro Kit is a comprehensive collection for performing interproximal reductions and allows the orthodontist to create space for crowded teeth, improve bite alignment, and enhance the overall appearance of the smile.

The kit contains all the abrasive tools needed by the orthodontist, such as strips, burs, discs, and a measuring gauge set, that are specifically designed to assist in interproximal reduction.

The kit offers a convenient and effective solution.



CAT #: ORTHOPRO1

Code	Content
MS-INTRO-KIT	
DD/D355-190-017F	
DD/D934-220-017M	
DISC-GUARD1	
ORTHOKIT1	
E11S/SF X 4 UNITS	
E11S/PF X 4 UNITS	
J316PF X 4 UNITS	
J316SF X 4 UNITS	
IPR-GAUGE-KIT	











Orthodontic Products

## Interproximal Reduction Pro Kit

The IPR Pro Kit is an upgrade to the unique tooth slenderizing kit.

The new set offers, aside from all of the necessary Diamonds for IPR stripping – 2 additional profiles.

Two pairs of our J316M + J313F patented IPR burs are added to give the doctors more options, more accuracy and more versatility in approaching IPR.

Profile	Cat. No.	Application
	J316SF	Interproximal stripping Diamond bur - 0.3 mm
	J316PF	Interproximal stripping Diamond bur - 0.4 mm
	J316M	Interproximal stripping Diamond bur - 0.5 mm
	Z12S/SF	Interproximal stripping Diamond bur - 0.45 mm
	Z12S/PF	Interproximal stripping Diamond bur - 0.5 mm
	J10F	Interproximal stripping Diamond bur
	E11S/SF	Interproximal stripping Diamond bur - 0.55 mm
	E11S/PF	Interproximal stripping Diamond bur - 0.65 mm
	J313F	Interproximal Rounding Diamond bur

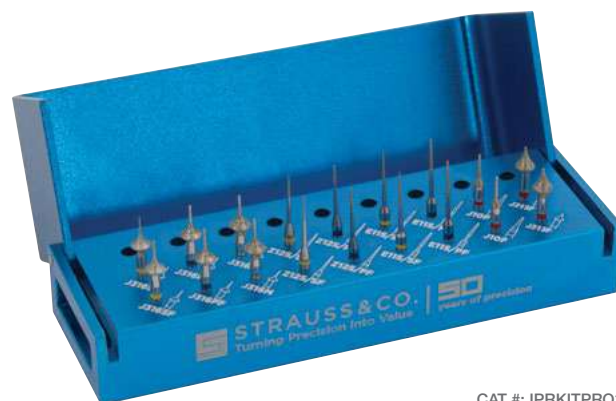

CAT #: IPRKITPRO1



SEE DEMO VIDEO



SEE DEMO VIDEO





Orthodontic Products

## Mini Discs

Introducing our new line of small discs.

The thin, flexible and highly durable discs make the life of any dentist or technician easier, while assuring that the quality of the work improves in the process. The discs are available in RA and HP form, are mounted on 2.35 mm shank mandrel and are individually packed.

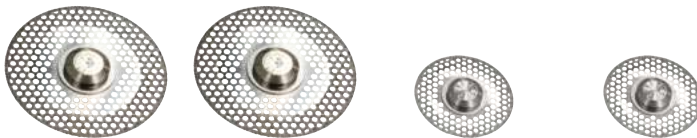

Cat. No.	DDRA/D400-140-020SF	DDRA/D400-180-020SF	DD/D400-140-020SF	DD/D400-180-020SF
Shape	400	400	400	400
Size	140	180	140	180
Sides	Double	Double	Double	Double
Thickness	0.2	0.2	0.2	0.2
Super Fine	◆	◆	◆	◆
Shank Type	RA	RA	HP	HP

## 12 Blades Bond Removal Bur

A unique Carbide bur for adhesive and bond removal.



12 Flutes	48L
Head Size	012
Head Length	8
12 Flutes FG	✳

## DISC-GUARD

Diamond disc guard, ensuring maximum patient safety while operating through narrow open gap



CAT # DISC.GUARD



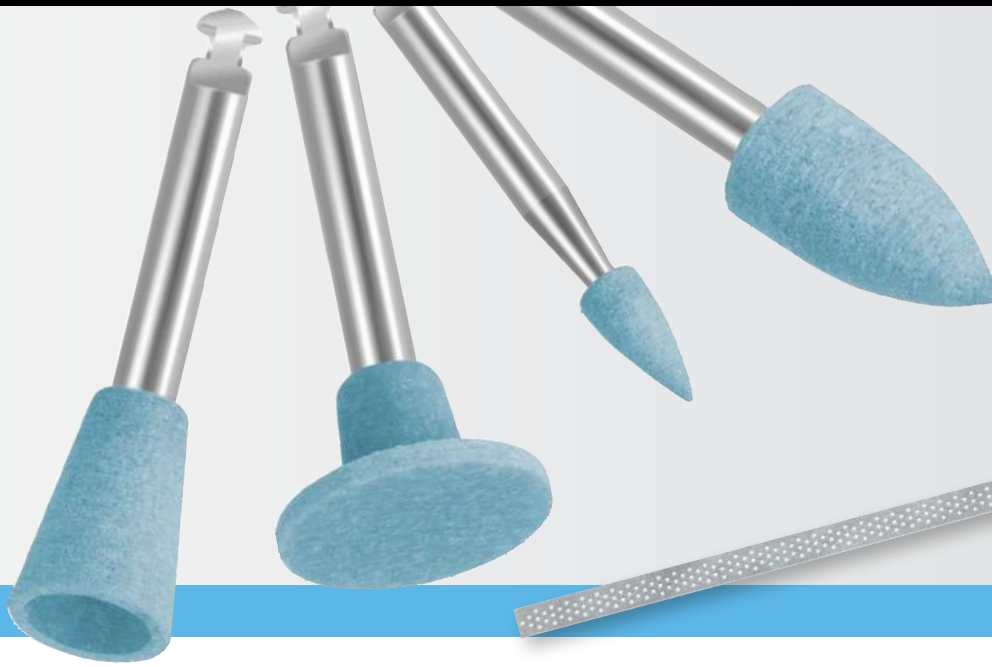

## Bond Removal Polishers

Adhesive and bond removal polishers, made with special glass type abrasive which has the benefit of being softer than the Enamel. Absolutely safe to use and does not scratch the Enamel surface.

Profile	Cat. No.
	RORPRORA11
	RORPRORA16
	RORPRORA17
	RORPRORA9

NEW  
NEW  
NEW  
NEW

## Diamond Serrated Strip

A Jagged, double sided strip, with gap for cement, bond and adhesive removal.



DS-SSAW4X150

Cat. No.	SF	F	M	Width (mm)	Side	Gap
DS-SSAW4X150	X	X	X	4	Single	Yes

The serrated Diamond Finishing Strips are used for contouring and removing excess material from the interproximal areas. The strips are designed with a serrated edge that separates interdental spaces quickly and a Diamond-coated abrasive area for efficient contouring, making the working procedures easier. The strips are made of high quality stable stainless steel.

These features make the serrated Diamond strip an effective and efficient tool in orthodontic treatment.



SEE DEMO VIDEO

Surgical Products

# Degranulation Kit

## Main Kit Features

- Designed morphologically to tear out all remnants of soft tissue which are firmly attached to the bone, removing them without harming the bone.
- The debridement process is done quickly and effectively.
- The drills are more precise and do not grab the bone compared to Tungsten burs.
- The drills are connected a physiodispenser working in sterile environment.
- Multi use suction which was designed specially to offer two major advantages; offer clear visibility and only remove fluids, leaving bone substitute in place.

## Advantages

- Optimal debridement of the inflammatory tissue is achieved, which cannot be done manually by surgical spoon curette.
- Multi task drills can be used in implantology, periodontal surgery, endodontic surgery, and root removal.
- Maximum safety when working near anatomical structure
- Multiuse drills (more than 100 procedures)

Cat. No.	Strauss G 1 mm	Strauss G 2.5 mm	Strauss G 3.0 mm	Strauss G 3.5 mm
Head Size	1 mm	2.5 mm	3.0 mm	3.5 mm
Head Length	31 mm	31 mm	31 mm	31 mm



CAT # GRKIT1

A unique selective re-usable suction that allows the physician to remove all fluids will leaving bone substitute in place



Designed by Dr. Efraim Kfir





## Surgical Products

# Safe Sinus Lift Kit

### Main Kit Features

- Patented burs with built in stoppers allow for maximum accuracy when performing a closed sinus lift procedure.
- Great visibility of the sinus membrane.
- No damage to the membrane.
- Fast and easy process.
- High durability burs – can be used for more than 100 cases.
- Accurate and consistent results.

### Advantages

- Can be connected to a physiodispenser for maximum sterility.
- Can be used in implantation, periodontic surgery and endo removal.
- Special A-traumatic Diamond burs with calibrated stopper.
- The special burs allow for a fast and accurate penetration of the hard tissue without harming the membrane.
- Unique thin suction which allows access into the cavity and give great visibility of the membrane.
- Custom made membrane separator curette is designed for circumferential antral membrane detachment and elevation all around the osteotomy site.

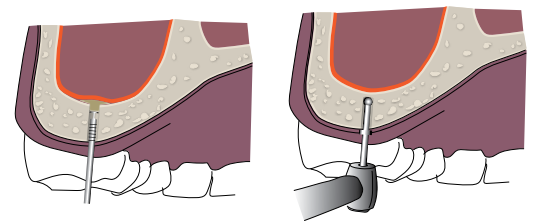

### SINKIT2

- 6 specialized burs with unique built-in calibrated stoppers (5-10mm)

### SINKIT3

- 9 specialized burs with unique built-in calibrated stoppers (2-10mm)
- Unique custom made Suction
- Customized Curette for lifting of Membrane

### SINKIT5

- 6 specialized burs with unique built-in calibrated stoppers (3-8mm)

### SINKITPRO1

- 9 specialized burs with unique built-in calibrated stoppers (2-10mm)
- 9 specialized Augmentation Burs with unique built-in stoppers (2-10mm)
- Unique custom made Suction
- Customized Curette for lifting of Membrane
- Custom Syringe for applying Bone Substitute



Item	Box Type	Drill Burs				Augmentation Burs	Suction + Adaptor	Curette - 2.5/2.8 mm	Curette - 3.5/4 mm	Bone Syringe
		2 mm	3, 4 mm	5-8 mm	9-10 mm	2-10 mm				
Sinkit2	Tray			*	*					
Sinkit3	Bur Block	*	*	*	*		*	*		
Sinkit5	Tray		*	*						
SinkitPRO1	Bur Block	*	*	*	*	*	*	*	*	*



Surgical Products

## Periodontic Root Planning Kit

A new set designed for optimal root planning and smoothing, the removal of Enamel pearls, dental calculus, adhesive and debris - making the root receptive and smooth surfaced for regeneration and the continuation of the Periodontic treatment.

The new Periokit was designed with Dr Meizi Eliezer, Periodontal Specialist of the Bern University in Switzerland.

The versatile set offers easy access at any point or depth, also enabling the physician to choose the method of treatment; surgical (opening a flap) or Minimal Invasive with the precision burs allowing for maximum versatility.

- The set includes various shapes and lengths of Diamond burs allowing for easy access including special laser markings for maintaining accurate working depth.
- The set includes High and Low speed burs, in 3 different grit levels, allowing the doctor maximum versatility to control the process and procedure.
- Recommended speed of use is 10K RPM (recommended range 8K-120K RPM).
- When working on hard stone, enamel pearls or adhesive, start with the BLUE marked bur and proceed to the YELLOW marked bur for optimal results.



CAT #: PERIOKIT2

Cat. No.	W-PER-E148SF	W-PER-K145SF	W-PER-E148-L/SF	W-PER-K145-L/SF	C2411S
Code	W831L-012	W832L-014	W831L-012-L	W832L-014-L	849-014
ISO No.	W249-012	W257-014	W249-012L	W257-014L	196-014
Head Size	12	14	12	14	014
Head Length	8	8	6	6	2
Total Length	28	28	34	34	23.5
XXF					◆
Super Fine	◆	◆	◆	◆	
Fine	◆	◆	◆	◆	
Medium	◇	◇	◇	◇	◇
Shank Type	RA	RA	RA	RA	FG





## New Implant Uncovering Bur

The new additions to our Ceramic bur line for soft tissue trimmers are the large and small rounded heads.

The new round head offers better approach, more surface area coverage and more accurate results.

The unique bur is operated without water, cauterizing the wound as it removes soft tissue preventing bleeding.

**Particularly suited for fast and easy implant exposure**

NEW NEW



Cat. No.	FG-CER-K0R	FG-CER-K2R
Head Size	15	23
Head Length	3.5	4.4
Total Length	24.5	24.5
FG	✳	✳



SEE DEMO VIDEO



## Soft Tissue Trimmer

- Designed for soft tissue surgery, the Ceramic soft tissue trimmer bur is a rotary instrument that can be used as an alternative to using scalpel, electro-surgery and surgical blades.
- Using the tissue trimmer provides minimum bleeding.
- The biocompatible hard oxide points are made to cut tissue without burning.



Cat. No.	FG-CER	FG-CEROS
Head Size	15	15
Head Length	5	8
Total Length	22.5	25
FG	✳	✳

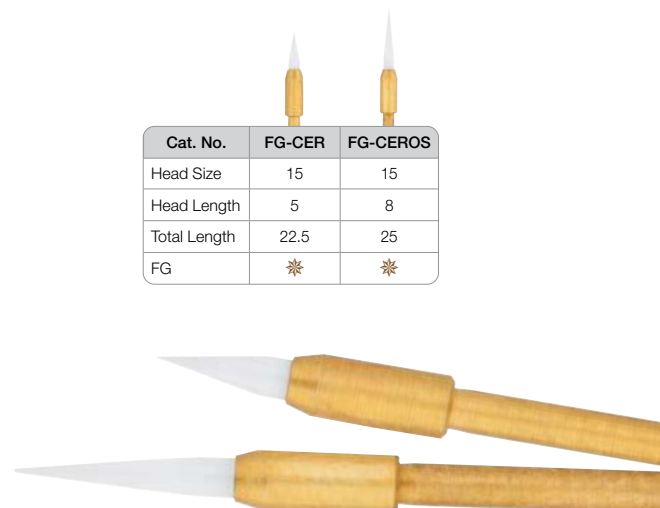
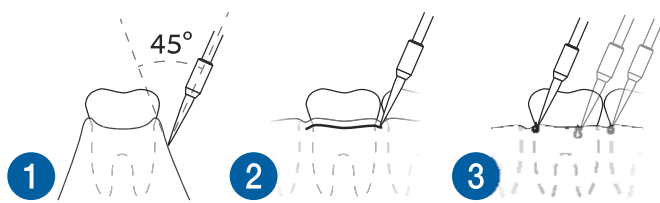



Surgical Products

## HP Surgical Burs

Special Diamond plated HP surgical burs. Made from high quality stainless steel offering accuracy concentricity and rustless sterilization.



Cat. No.	H001-014	H001-016	H001-018	H001-030	H001-035	H001-042
Code	801-014	801-016	801-018	801-030	801-035	801-042
ISO No.	001-014	001-016	001-018	001-030	001-035	001-042
Head Size	14	16	18	30	35	42
Head Length						
Total Length	44.5	44.5	44.5	44.5	44.5	44.5
Medium	▽	▽	▽	▽	▽	▽
Coarse				▽	▽	▽

## FG End Cutting Burs

The STRAUSS & CO. line of end cutting burs is designed to make accurate, small corrections without risk of causing peripheral damage. The burs feature an active tip while the rest of the bur is inactive.



Cat. No.	PR8L	PR015L
Code	839L-010	839L-015
ISO No.	150-010	150-015
Head Size	10	15
Head Length		
Total Length	24	24
Fine		
Medium	▽	▽

## FG XL Surgical Burs

Round extra-long burs for surgical use.

NEW NEW NEW NEW



Cat. No.	A2XL	A3XL	A4XL	A5XL
Code	801XL-014	801XL-018	801XL-022	801XL-032
ISO No.	001-014	001-018	001-022	001-032
Head Size	014	018	022	32
Head Length				
Total Length	28	28	28	28
Medium	▽	▽	▽	▽
Coarse	▽	▽	▽	▽

## Surgical Length Barracuda

This versatile Metal cutting lineup which includes both regular Barracuda burs as well as the stronger, more aggressive Barracuda Ultra burs has recently seen the introduction of a much missed addition to the family - long surgical Metal cutting burs.

Using longer Metal cutting burs offers tremendous advantages.

The OS burs (Operative Surgical) enable accessing hard to reach areas while using far less effort and achieving the desired outcome with greater ease.

The burs can also be used in removing and accessing broken / problematic screws on implants and bridges - a task which up until now would require the physician to use a specialized instrument.

Aside from great precision and performance, the extended shank allows for versatility and creativity.



Cat. No.	FGB1557OS	FGB4OS
Code	B1557-OS	B4-OS
ISO No.	139-010	001-014
Head Size	10	14
Head Length	4	
Total Length	25	25
FG	✳	✳

## Barracuda Ultra

The Barracuda Ultra burs are technologically designed to provide fast and superior results in:

- Implant processing.
- Crown cutting.
- Crown and bridge preparation.

The Barracuda Ultra is a one-piece solid Carbide construction results in a longer lasting, smoother cutting instrument.



Cat. No.	FG-K2R	FG-F09	FG-F10	FG-F21R	FG-M3	FG-M31	FG-C31
Description	Football	Flat end taper			Round end taper		
Head Length	4.5	8	8	8	8	8	8
Head Size	023	016	018	020	016	018	023



**100% Control**



SEE DEMO VIDEO

Kits - Crown Cutting

# Crown Cutting Kits

## Zirconia Cutting / PFM Cutting

Designed by Dr. Eyal Tarazi

For many years, the STRAUSS & CO. Magic Touch line has been the leading, most popular solution for all adjustments on Zirconia, Porcelain and Emax.

Our unique, patented line of burs is renowned to provide the most homogeneous Diamond bur of its kind - preventing the formation of Micro-fractures and cracks in the material while working.

The result is a smooth, accurate Diamond bur which enables working on Zirconia as quickly and easily as working with Composites.

Now, comes the next leap forward in the our Magic Touch technology.

The all new Magic Touch Cutting burs were designed specifically to offer superior cutting of Zirconia, Porcelain and Emax at incredible ease and accuracy on a level never before available in the rotary Diamond Bur industry!

The burs, which were carefully selected and designed from scratch to offer specific shapes and sizes geared towards cutting from multiple angles at any desired depth.

These new shapes have have not been previously available in the Magic Touch line.

The new collection of Magic Touch cutting burs is a further upgrade to our line of specialty products adding depth and versatility - offering a single stop for all your Ceramic cutting needs.

- Cuts 2-3 time faster than conventional zirconia cutters
- Unique Geometry
- Easy to use from various angles

Cat. No.	G3PF	PR55PF
Shape	818-050	PR55-050
Head size	50	55
Head length	0.7	0.9
Total length	19	19.5
Grit size	◆	◆

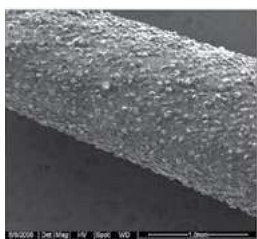
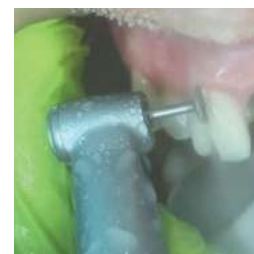

MAGIC TOUCH BUR  
MAGRIFICATION 100X

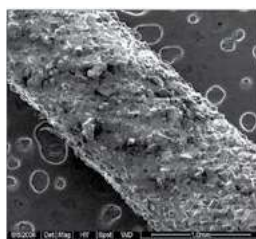

REGULAR FG DIAMOND  
MAGRIFICATION 100X

### Magic Touch generates less heat when cutting

Statistical data analysis showed significant difference between Heat generation while using with two different kinds of burs. The temperature reached in most cases was higher for the regular "FG diamond burs" than for Magic Touch burs.

### Magic touch burs produce a smoother surface

The samples machined with Magic Touch burs, both on Porcelain and Zirconia, were significantly smoother than the samples machined with coarse burs.





Kits - Crown Cutting

## Zirconia Cutting Kit

Zirconia Crown cutting kit, which includes a complete refill for every bur featured

Profile	Cat. No.
	PR55PF
	G3PF
	M3PF
	E12PF
	A3PF

Cat No. ZIRKIT1 - Kit featuring 5 single unique burs  
Cat No. ZIRKITPRO1 - Kit + full set refills

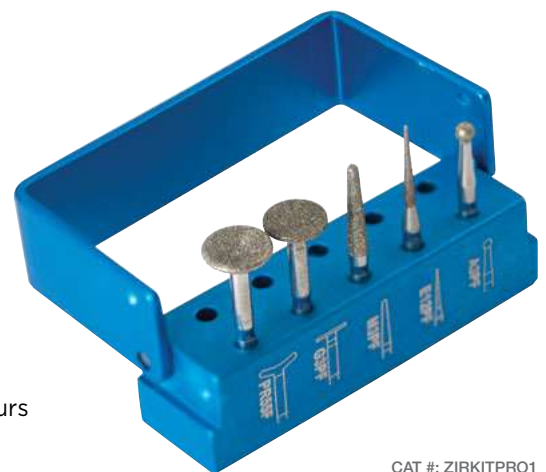

CAT #: ZIRKITPRO1

## PFM Cutting Kit

A kit for PFM / PFZ crown cutting which includes a complete refill for every bur featured

Profile	Cat. No.
	PR55PF
	M3PF
	FGB331
	FGB1558
	FG-M3

Cat No. FFMKIT1 - Kit featuring 5 single unique burs  
Cat No. PFMKITPRO1 - Kit + full set refills



CAT #: PFMKITPRO1

### Refills - Magic Touch

Cat. No.	G3PF	PR55PF	M3PF	E12PF	A3PF
Code	818-050	PR55-050	856L-018PF	858-012PF	801-018PF
ISO No.					
Head Size	50	55	018	012	018
Head Length	0.7	0.9	9	8	
Total Length	19	19.5	21	19	19
Grit size	◆	◆	◆	◆	◆

### Refills - Barracuda Metal cutter

Cat. No.	FGB331	FGB1558	FG-M3
Code	331	1558	856-016
ISO No.	010	012	016
Head Size	015	012	018
Head Length	2	4.1	8
Total Length	19	19	19
FG	✱	✱	✱



Kits

## OccluZinator Zirconia Burs

### A true revolution in Zirconia adjustments!

The original Occlusionator burs were originally designed for advanced Composite sculpting by Dr Patrick Roetzer.

Now, plated with our patented Magic Touch Diamond grit, these burs are designed specifically for sculpting and adjusting Porcelain, Zirconia, Ceramic and Emax.

The burs allow the doctor to accurately sculpture a crown chairside without the risk of causing micro-fractures and cracks.

The advanced OCZKIT2 also features Zirconia Polishers for achieving a final high luster shine.

Designed by Dr. Patrick L. Roetzer, DDS, FICD, FACD  
 Director of Operative Dentistry  
 University of the Pacific/Arthur A. Dugoni School of Dentistry

Profile	Cat. No.	Application
	PR262PF	Occluzinator Zirconia Adjustment Bur - Large
	K306PF	Occluzinator Zirconia Adjustment Bur - Xmas
	PR151PF	Occluzinator Zirconia Adjustment Bur - Small



CAT #: OCZKIT1

Profile	Cat. No.	Application
	PR262PF	Occluzinator Zirconia Adjustment Bur - Large
	K306PF	Occluzinator Zirconia Adjustment Bur - Xmas
	PR151PF	Occluzinator Zirconia Adjustment Bur - Small
	RDRAZ14M	Rubber Diamond Ra Spiral 14mm Shape For Zirconia - Medium (Green) ##
	RDRAZ14F	Rubber Diamond Ra Spiral 14mm Shape For Zirconia - Fine (Pink)



CAT #: OCZKIT2



Kits

## Magic Touch Polishing Pro Kit

The kit includes polishers for various materials alongside a wide variety of Magic Touch burs allowing for maximum versatility and convenience.

This set offers all the various shapes of Magic Touch burs in a single package, also featuring a complete selection of the correct polishers for the various materials worked on.

While the Diamond burs will always get the desired end result - it is important to match the correct polisher to the right material. This set will enable the doctor to have all the necessary burs and polishers no matter the procedure - or material faced with.

Profile	Cat. No.	Application
	A3PF	Round Diamond Bur Magic Touch
	A4PF	Round Diamond Bur Magic Touch
	E5PF	Flame Diamond Bur Magic Touch
	E7PF	Pointed Cylinder Diamond Bur Magic Touch
	K2PF	Football Diamond Bur Magic Touch
	PR15PF	Needle Diamond Bur Magic Touch
	PR2PF	Flame Diamond Bur Magic Touch
	T2PF	Gingival Curettage Diamond Bur Magic Touch Blue Color
	M3PF	Round End Taper Diamond Bur Magic Touch
	K2RPF	Football Diamond Bur Magic Touch
	RDRA14C	Rubber Diamond Spiral 14mm Shape For Ra - Coarse (Blue)
	RDRA14F	Rubber Diamond Spiral 14mm Shape For Ra - Fine (Gray)
	RDRA14M	Rubber Diamond Spiral 14mm Shape For Ra - Medium (Pink)
	RDRAE14F	Rubber Diamond Spiral 14mm Shape For E-Max Ra - Fine (Gray)
	RDRAE14M	Rubber Diamond Spiral 14mm Shape E-Max Ra - Medium (Brown)
	RDRAZ14F	Rubber Diamond Ra Spiral 14mm Shape For Zirconia - Fine (Pink)
	RDRAZ14M	Rubber Diamond Ra Spiral 14mm Shape For Zirconia - Medium (Green)



CAT #: MAGICTPRO1



Kits

## Cavity Preparation and Restoration Polishing Kit

A comprehensive kit designed to make the job of preparing, fixing cavities and restoration polishing as quick, accurate and easy as possible.

The all new CAVPSET1 includes all the necessary Diamond burs for the procedure, embracing a back to basics approach.

Profile	Cat. No.	Application
	FG330	Carbide Dental Bur #330
	D1M	Flat End Cylinder Diamond Bur Medium Grit
	AB4M	Pear Shape Diamond Bur Medium Grit
	B2M	Inverted Cone Diamond Bur Medium Grit
	B3M	Inverted Cone Diamond Bur Medium Grit
	A1M	Round Diamond Bur Medium Grit
	PR2SF	Flame Diamond Bur Super Fine Grit
	PR2XXF	Flame Diamond Bur Extra Extra Fine Grit
	K2RSF	Football Diamond Bur Super Fine grit
	K2RXXF	Football Diamond Bur Extra Extra Fine grit
	RA4	Carbide Dental Bur Round Ra #4
	RA6	Carbide Dental Bur Round Ra #6



CAT #: CAVPSET1

## Maryland Bridge Kit

A comprehensive kit designed for taking a minimally invasive approach to temporary restorations, long-term temporary restorations, or permanent restoration through fixed resin bridges glued together (Maryland bridges).

Developed by Dr. Yuval Wind

Profile	Cat. No.	Application
	G32-X	Precision Depth Marker - 0.5 mm
	G33-X	Precision Depth Marker - 0.7 mm
	Z34RM	Taper Rounded Shoulder Diamond Bur Medium Grit
	Z34RF	Taper Rounded Shoulder Diamond Bur Fine Grit
	PR151F	Mini Occlusinator
	A2M	Round Diamond Bur Medium Grit
	PR8F	End Cutting Diamond Bur Fine Grit
	FG-EF3	Carbide dental FG bur - 12 blades
	K2RPF	Football Diamond Bur Magic Touch
	M3PF	Round End Taper Diamond Bur Magic Touch



CAT #: MARYLANDKIT1

Profile	Cat. No.	Application
	RCPRA10M	Composite Finishing Diamond Spiral Polisher
	RDRAZ14M	Emax Finishing Diamond Spiral Polisher - Medium
	RDRAE14F	Emax Finishing Diamond Spiral Polisher - Fine



Kits

## Carbide Cutters Kit

The Carbide Cutters Kit is a comprehensive collection of Carbide burs designed ideally for trimming and shaping titanium and non-precious Metals, plaster and other soft materials without clogging or chattering.

The kit contains burs in various shapes and grit sizes offering the physician the opportunity to work on any soft material from Metal to plaster and achieve the desired level of cutting, the most accurate contouring and the best end result - every time.

The Carbide Cutters kit is a marvel in the right hands offering yet another smart solution to an everyday challenge.

Profile	Cat. No.
	CC141-023F
	CC200-040C
	CC275-060M
	CC200-040SC
	CC275-060C
	CC200-045M
	CC275-060F
	CC275-060SF



CAT #: CC-KIT1

## HP Starter Kit

A complete set of Hand Piece burs and polishers offering maximum versatility and precision.

The set included Diamond discs, Carbide cutters and polishers.

Profile	Cat. No.	Application
	RACHP34M	Acrylic Polishers - HP Bullet Shape Medium Grit
	RACHP34SC	Acrylic Polishers - HP Bullet Shape Super Coarse Grit
	RUHP26M	Universal Polishers - HP Knife Edge Wheel Shape Medium Grit
	DD/D402-220-017F	Mounted Diamond Disc Thickness 0.17 Grit Size Fine Double Side
	RDHPL2SC	Rubber Diamond Flat And Tapered Shape For Zirconia Lamps Super Coarse Grit
	HP559	Carbide Hand Piece Bur #559
	CC201-050M	Carbide Cutter Shape 201-050 Medium Grit
	CC275-060C	Carbide Cutter Shape 275-060 Coarse Grit
	CC201-070SC	Carbide Cutter Shape 201-070 Super Coarse Grit
	H27RM	Diamond Bur Hand Pieces
	CC141-023F	Carbide Cutter Shape 141-023 Fine Grit



CAT #: HP-STRT-KIT1



Endodontic Products

## Extended Endo Bur

The F1RXL is an extra-long 31 mm bur, which offers fantastic clear visibility, allowing quicker, far more precise work.

Designed by Dr. Amir Weizmann.

Cat. No.	F1RXL
Code	850-016
ISO No.	199-016
Head Size	016
Head Length	10
Total Length	31
Fine	▼
Medium	▽
Coarse	◆
S. Coarse	

Round End Taper



SEE DEMO VIDEO

## Laser Marked FG Diamond Burs

Cat. No.	A1L-ML/C	A3L-ML/C
Code	801L-012	801L-018
ISO No.	001-012	001-018
Head Size	012	018
Head Length		
Total Length	24	24
Fine		
Medium		
Coarse	◆	◆
S. Coarse		

Surgical Length Round Laser Marked

Cat. No.	PR1210S-ML
Code	802L-016
ISO No.	464-016
Head Size	012/016
Head Length	5
Total Length	23
Fine	
Medium	
Coarse	◆
S. Coarse	

Endo Access Laser Marked

Laser marked at 5, 6 and 7.5 mm to ensure the correct depth

## Endodontic Pro Kit

A complete endodontic kit, ideal for Initial treatment and retreatments.

- Contains laser marked burs to ensure precise depth.
- Designed by Dr. Iris Slutzky, Endodontic Department, Hadassah University Dental School.

Profile	Cat. No.	Application
<b>INITIAL TREATMENT</b>		
	FG-ENDOZ152	Create The Outline Of The Cavity
	A1L-ML/C	Initial Penetration Into The Pulp Chamber – Laser Depth Markings
	A3L-ML/C	Initial Penetration Into The Pulp Chamber – Laser Depth Markings
	MR10L3M	Long Bur With A Short Side Cutting For Revealing The MB li Canal
<b>RETREATMENT BURS</b>		
	A3PF	Gaining Access Through The Occlusal Surface Of A Tooth Restored With A Zirconia / Porcelain Crown
	FGB1558	Drill Through The Metal Portion Of The Crown Or Through Amalgam Or Casted Core
	C09C	Decomposition Of The Post And Core During A Retreatment
	PR1210S-ML/C	Deroofing Bur - Complete The Access Cavity And Remove Interferences
	M4M	Occlusal Adjustment After Completion Of The Treatment



CAT #: ENDOSET2

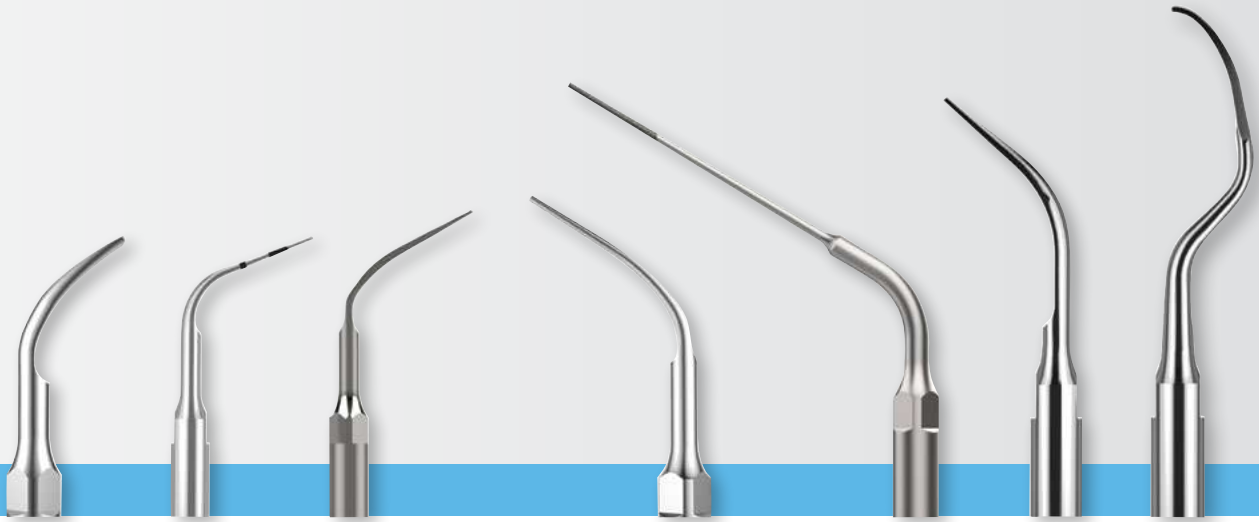

Tips

## Ultrasonic Tips

STRAUSS & CO is introducing a new line of scaler tips, designed to deliver precision and accuracy in periodontal cleaning. Made from special materials to ensure strength, flexibility, and long-lasting tip life, these scaler tips undergo a rigorous manufacturing process that involves advanced Japanese CNC machines and extensive inspections, making them a new and reliable option for dental professionals.



**TIP-TW EMS P**  
(Torque wrench)  
EMS - TW EMS P  
(Torque wrench)



**TIP-TW SAT P**  
(Torque wrench)  
SATELEC - TW SAT P  
(Torque wrench)

### EMS Compatible



Cat no.	TIP-G1	TIP-G2	TIP-G3	TIP-G4	TIP-G5	TIP-eA	TIP-eP	TIP-ePS	TIP-P1	TIP-P3	TIP-P3D	TIP-P4	TIP-E3D
Diamond Coated	NO	NO	NO	NO	NO	NO	NO	NO	NO	NO	YES	YES	NO
Head Size	0.4	0.35	0.4	0.4	0.48	0.4	0.4	0.35	0.4	0.5	0.5	0.5	0.6
Head Length	9.5	6	14	10.5	9.3	1.6	14.5	16	9.5	13.7	13.7	10.5	17.7
Total Length	21.3	21	24	21.5	23	21.5	23.5	23.5	21.5	24	24	25	24.9

### SATELEC Compatible



Cat no.	TIP-GD1	TIP-GD3	TIP-GD4	TIP-GD5	TIP-S#1	TIP-S1S	TIP-PD1	TIP-PD3
Diamond Coated	NO	NO	NO	NO	NO	NO	NO	NO
Head Size	0.4	0.4	0.4	0.48	0.48	0.55	0.4	0.5
Head Length	9.5	14	10.5	9.3	9.5	12.9	9	13.7
Total Length	21.3	24	21.5	23	22.8	31.4	21.5	24



Cat no.	TIP-PD4	TIP-S10X	TIP-X10P	TIP-S10Z	TIP-SH3	TIP-ED1	TIP-ED3D	TIP-ED4
Diamond Coated	YES	NO	NO	NO	NO	NO	YES	YES
Head Size	0.5	0.5	0	0.35	0.7	0	0.6	0.5
Head Length	10.5	13	0	15.3	7.5	0	17.7	31
Total Length	25	20	0	21	30.2	0	24.9	28.8



## Polishing Products

Strauss & Co. offers occlusal and spiral Diamond polishers for Composite, Lithium Disilicate, Zirconia, and Porcelain. Designed to deliver great results with ease., these polishers are crafted to simplify the polishing process and ensure a smooth and uniform finish on dental restorations.

## Porcelain Polishers – RA

NEW NEW NEW



Cat. No.	RD-RA-5.5F	RD-RA-5.5M	RD-RA-5.5C
Grit	Fine	Medium	Coarse
Size (mm)	5,5 x 8,8		
Shape	Occlusal		
RPM	3.000 – 8.000 min-1 max. 20.000 min-1		



Cat. No.	RD-RA-14F	RD-RA-14M	RD-RA-14C
Grit	Fine	Medium	Coarse
Size (mm)	5,5 x 8,8		
Shape	Spiral		
RPM	7.000 – 12.000 min-1 max. 20.000 min-1		

## Composite Polishers – RA

NEW NEW



Cat. No.	RCP-RA-5.5F	RCP-RA-5.5M
Grit	Fine	Medium
Size (mm)	5,5 x 8,8	
Shape	Occlusal	
RPM	3.000 – 8.000 min-1 max. 20.000 min-1	



Cat. No.	RCP-RA-10F	RCP-RA-10M	RCP-RA-14F	RCP-RA-14M
Grit	Fine	Medium	Fine	Medium
Size (mm)	11 x 1,6		14 x 1,6	
Shape	Spiral		Spiral	
RPM	3.000 – 8.000 min-1 max. 20.000 min-1			

## Zirconia Polishers – RA



Cat. No.	RD-RA-Z14F	RD-RA-Z14M
Grit	Fine	Medium
Size (mm)	14 x 1,6	
Shape	Spiral	
RPM	7.000 – 12.000 min-1 max. 20.000 min-1	

## Lithium Disilicate Polishers – RA



Cat. No.	RD-RA-E14F	RD-RA-E14M
Grit	Fine	Medium
Size (mm)	14 x 1,6	
Shape	Spiral	
RPM	7.000 – 12.000 min-1 max. 20.000 min-1	





# Minimal Invasive

The STRAUSS & CO. minimal invasive burs make up a unique line of precision instruments.

The burs are designed for the opening of fissures and for endodontic work.

The long neck and small head size offer excellent and direct visibility when working under a microscope or in any case when the doctor's field of vision is impaired.

The familiar lineup of the rounded head burs has been revamped and now offers brand new shapes such as flame, football and cylinder while offering the same advantages as before without compromise.

The extended line of minimal invasive burs with its new additions add versatility, precision and new methods for treatments to an already outstanding lineup.

NEW NEW NEW NEW

Cat. No.	MA-D082FR	MA-E073	MA-E143	MA-K123
Code	838-008	889007	390-014	368-012
ISO No.	138-008	540-007	254-014	257-012
Head Size	8	7	14	12
Head Length	2	2.6	3	2.4
Total Length	21	21	21	21
Medium	▽	▽	▽	▽

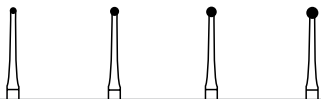

Cat. No.	MA0M	MA1M	MA2M	MA25M
Code	801-009	801-012	801-014	801-016
ISO No.	001-009	001-012	001-014	001-016
Head Size	9	12	14	16
Head Length				
Total Length	21	22	22	22
Grit Size	▽	▽	▽	▽

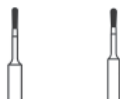

Cat. No.	MAB0M	MAB3M
Code	830-008	830-010
ISO No.	237-008	237-010
Head Size	8	10
Head Length	2.5	2.5
Total Length	19	19
Grit Size	▽	▽





CAD/CAM

## CAD/CAM Burs

Experience accuracy, versatility, durability and performance at the highest levels.

STRAUSS & CO. now provides Diamond and Carbide burs specially designed to work on most popular CAD/CAM milling machines.

The wide variety of Diamond and Carbide milling burs lives up to the STRAUSS & CO. guarantee to its fullest... High precision, high performance instruments at great value.

### Diamond CAD/CAM Burs



Cat. No.	CAD-AMD-0.4x43	CAD-AMD-1.0x43	CAD-AMD-1.4x43	CAD-AMD-1.8x43
Overall Length	43	43	43	43
Ø Shank mm	3.0	3.0	3.0	3.0
Ø Head mm	0.4	1.0	1.4	1.8
Material	Glass Ceramics			

Amann Girrbach



Cat. No.	PR1.0-10	PR1.35-01	PR1.75-01	PR5- 0.6-01	PR5- 1.2-01	PR5- 1.4-01	PR5- 2.2-01
Overall Length	38	38	38	36	36	36	36
Ø Shank mm	3.5	3.5	3.5	3.0	3.0	3.0	3.0
Ø Head mm	1	1.35	1.75	1.1	1.7	1.3	2.2
Material	Glass Ceramics						
Machine	CEREC MCXL			CEREC 5			

Sirona

### Carbide CAD/CAM Burs



Cat. No.	CAD-AMG-003x47	CAD-AMG-006x47	CAD-AMG-010x47	CAD-AMG-025x47	CAD-AMG-C-006x47	CAD-AMG-C-010x47	CAD-AMG-C-025x47
Overall Length	47	47	47	47	47	47	47
Ø Shank mm	3	3	3	3	3	3	3
Ø Head mm	0.3	0.6	1	2.5	0.6	1	2.5
Number of Teeth	2	2	2	2	2	2	2
Coating	No			Coated			
Material	Zirconia, Wax						
Machine	Motion 1 + 2, Mikro						

Amann Girrbach

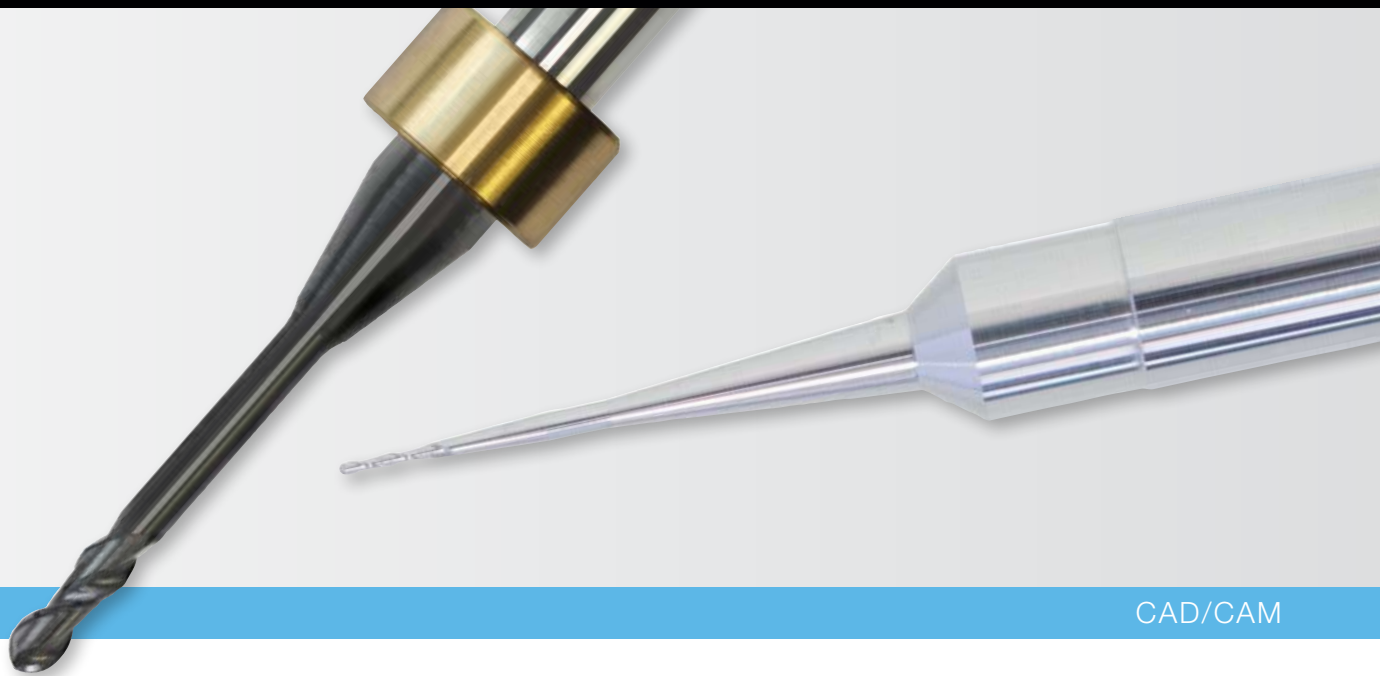

### Carbide CAD/CAM Burs



Cat. No.	CAD-I6C-C-006X053	CAD-I6C-C-010X053	CAD-I6C-C-025X053
Overall Length	53	53	53
Ø Shank mm	6	6	6
Ø Head mm	0.6	1	2.5
Number of Teeth	2	2	2
Coating	Coated		
Material	Zirconia, PMMA, Wax		
Machine	Coritec 350i / Schütz Tizian Cut 5 / Kulzer Cara AS Mill		

Imes Icore



Cat. No.	CAD-MCS-PM-005x42	CAD-MCS-PM-010x42	CAD-MCS-PM-025x43	CAD-MCS-Z-C-005x42	CAD-MCS-Z-C-010x42	CAD-MCS-Z-C-025x43
Overall Length	42	43	44	42	43	44
Ø Shank mm	3	3	3	3	3	3
Ø Head mm	0.5	1	2.5	0.5	1	2.5
Number of Teeth	2	2	2	2	2	2
Coating	Not Coated			Coated		
Material	PMMA			Zirconia		
Machine	MCX5					

Sirona



Cat. No.	CAD-RDC-C-006X050	CAD-RDC-C-010X050	CAD-RDC-C-020X050	CAD-RDC-D-006X050	CAD-RDC-D-010X050	CAD-RDC-D-020X050
Overall Length	50	50	50	50	50	50
Ø Shank mm	4	4	4	4	4	4
Ø Head mm	0.6	1	2	0.6	1	2
Number of Teeth	2	2	2	2	2	2
Coating	Coated			Diamond		
Material	Zirconia, PMMA, Wax					
Machine	DWX4, DWX51/52					

Roland



Cat. No.	CAD-Z3C-005x057	CAD-Z3C-010x057	CAD-Z3C-020x057	CAD-Z6C-005x050	CAD-Z6C-010x050	CAD-Z6C-020x050
Overall Length	57	57	57	50	50	50
Ø Shank mm	3	3	3	6	6	6
Ø Head mm	0.5	1	2	0.5	1	2
Number of Teeth	2	2	2	2	2	2
Material	Zirconia			Zirconia		
Machine	M1, M3, M5 (3mm shank)			M1, M4, M5, M6 (6mm shank)		

Zirkozahn



FG Diamond Burs

# FG Diamond Burs

High quality, high precision Diamond burs which features new Grit size options.



Cat. No.	B1
Code	805-012
ISO No.	010-012
Head Size	012
Head Length	1.3
Total Length	19
S. Fine	
Fine	◆
Medium	◇
Coarse	◇
S. Coarse	

**Inverted Cone**



Cat. No.	AB144	AB325
Code	830L-014	830L-032
ISO No.	239-014	239-032
Head Size	014	032
Head Length	4.1	5.1
Total Length	19	19
S. Fine		◆
Fine		◆
Medium	◇	◇
Coarse	◇	
S. Coarse		

**Pear**



Cat. No.	k3
Code	825-038
ISO No.	164-038
Head Size	038
Head Length	7
Total Length	21
S. Fine	◆
Fine	
Medium	◇
Coarse	◇
S. Coarse	

**X-Mas Tree**



Cat. No.	F2
Code	848-018
ISO No.	173-018
Head Size	018
Head Length	10
Total Length	22.5
S. Fine	◆
Fine	◆
Medium	◇
Coarse	◇
S. Coarse	◆

**Flat End Taper**



Cat. No.	E76S	E72	E76
Code	885-016	886-012	886-016
ISO No.	130-016	131-012	131-016
Head Size	016	012	016
Head Length	8	10	10
Total Length	24	24	24
S. Fine		◆	
Fine		◆	◆
Medium	◇	◇	◇
Coarse	◇	◇	◇
S. Coarse			

**Pointed Cylinder**



Cat. No.	T6
Code	879K-018
ISO No.	299-018
Head Size	018
Head Length	9.5
Total Length	22
S. Fine	◆
Fine	◆
Medium	◇
Coarse	◇
S. Coarse	◆

**Gingival Curettage**

FG Diamond Burs

NEW



Cat. No.	M42	PR3510
Code	811R-033	370-035
ISO No.	038R-033	039R-035
Head Size	033	035
Head Length	5.5	10.5
Total Length	21	23
S. Fine		
Fine		◆
Medium	◇	◇
Coarse	◇	
S. Coarse		

Barrel



Cat. No.	D5R
Code	837KR-016
ISO No.	158-016
Head Size	016
Head Length	8
Total Length	21.5
S. Fine	
Fine	◆
Medium	◇
Coarse	◇
S. Coarse	

Cylinder Rounded Shoulder



Cat. No.	J316		
Code	465-031		
ISO No.	833-031		
Head Length	5		
Total Length	20		
ø for IPR SF (mm)	◆	Min	0.30
		Max	0.30
ø for IPR PF (mm)	◆	Min	0.40
		Max	0.40
ø for IPR M (mm)	◆	Min	0.50
		Max	0.50

Orthodontic



Cat. No.	D31	D11	D13	D12	D5
Code	835-012	836-010	836-014	837-010	837-016
ISO No.	109-012	110-010	110-014	111-010	111-016
Head Size	012	010	014	010	016
Head Length	4	6	6	8	8
Total Length	19.5	21	21	21.5	21.5
S. Fine					
Fine	◆	◆	◆	◆	◆
Medium	◇	◇	◇	◇	◇
Coarse	◇	◇	◇	◇	◇
S. Coarse					◆

Flat End Cylinder



Cat. No.	C1	C13
Code	855-014	856L-014
ISO No.	197-014	199-014
Head Size	014	014
Head Length	6.3	9
Total Length	21	22
S. Fine		
Fine	◆	◆
Medium	◇	◇
Coarse	◇	◇
S. Coarse	◆	

Round End Taper



Cat. No.	E53
Code	863-010
ISO No.	250-010
Head Size	010
Head Length	10
Total Length	24
S. Fine	◆
Fine	◆
Medium	◇
Coarse	◇
S. Coarse	

Flame



Accessories

## Metal Bur Blocks

High quality autoclavable Metal bur block for RA and HP burs.

Easily organizes burs for various physicians or procedures.

Cat. No.	Description
PKBBM8RA2	Aluminum bur block - 8 RA
PKBBM37HP2	Aluminum bur block - 37 HP



8RA BUR BLOCK  
 CAT #: PKBBM8RA2



37HP BUR BLOCK  
 CAT #: PKBBM37HP2

## Sharpening Stone



CAT #: SHRPSTN1

The sharpening stone is a valuable tool in the dental industry, providing a reliable and efficient way to sharpen and maintain instruments used in dental procedures.

From scalers, curettes, or other dental instruments, this sharpening stone helps keep them in top condition for optimal performance.

Made from Premium choice materials, the sharpening stone is durable and long-lasting, making it a smart investment for any dental practice.

## Bur Brush

A bur brush made of quality Metal bristles, for cleaning dental burs ahead of sterilization



CAT #: BUR.BRUSH

## HP/RA – FG Adaptors

When searching for the right bur to use, physicians and technicians will often find themselves having to settle.

Often, a specific FG bur may only be available for a high-speed turbine, when the doctor is looking to use a Contra Angle low speed connection or a Hand Piece.

For this reason, Strauss & Co. now offers the FG adaptor.

This adaptor is designed to connect any FG high speed bur into a RA low speed or HP device with great ease - never having to settle again.

The adaptor is a perfect tool not just for getting the bur you want with the connection you want - but also offers the physician an entirely new way to approach any challenge faced with ingenuity and creativity.



Cat. No.	ADPTR-H-FG-35	ADPTR-W-FG-13	ADPTR-W-FG-26	ADPTR-W-FG-34
Code	HP to FG	RA to FG	RA to FG	RA to FG
Total Length	35	13	26	34

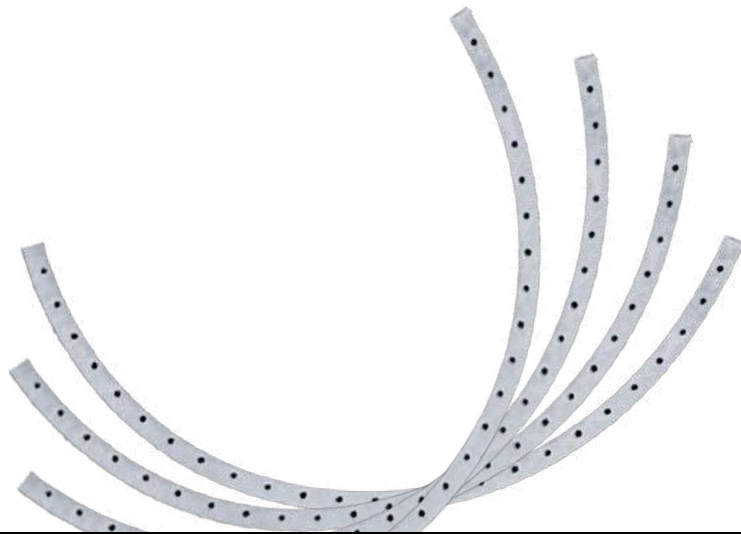

## 50 Years of Strauss & Co.



We opened our doors in 1970 as a family run private company and have remained so to this day.

Our products have always spoken for themselves.

The uncompromising quality, meticulous attention to details, our service, flexibility and creativity have provided thousands of unique products and solutions over the years.

Our products are sold in over 70 countries around the world in both the dental field and various industrial fields.

But who are we as a company? What do you really know about us? What makes us special? Watch the video and get to know us a little better...





19 Hayezira St. Industrial Area, P.O.Box 2521, Raanana 4366363 Israel  
Tel: +972-9-7461631 | Fax: +972-9-7461636  
www.strauss-co.com | Email: info@strauss-co.com

U.S.A Office: 9 Florida Park drive north, Palm coast FL 32137 USA  
Tel: 1-800-9829641 (203)221-1332 | Fax:(203)226-0105 | Email: Info@straussdiamond.com

German Office – Strauss DE:  
Eichholzer Strasse 7a Marschacht 21436 Deutschland  
Tel: +49(0)4176-9484770 | Fax: +49(0)4176-9484771 | Email: info@strauss-deutschland.de