

# OSSTEM ORTHODONTICS SOLUTION

PRODUCT CATALOGUE



Brackets



Archwires



Mini Implant



Buccal tubes



Elastomerics



Instruments



OSSTEM ORTHODONTICS Inc.

Headquarter

#303, 112, LS-ro, Dongan-gu, Anyang-si, Gyeonggi-do, 14118 Republic of Korea

TEL. +82-31-477-9903 FAX. +82-2-319-5449 Email: info@osstemortho.com





OSSTEM  
ORTHODONTICS  
SNS channel



**OSSTEM**<sup>®</sup>  
ORTHODONTICS

# Contents

<b>* Intro</b>	About us	04
	History	05
<b>* Brackets</b>	Self-Ligating Brackets	08
	MAJESTY Ceramic	14
	MAJESTY Metal	19
	YES	23
	Aesthetic Brackets	28
	Perfect Clear	34
	Perfect Clear 2	38
	OK Real Resin Bracket	41
	Metal Brackets	44
	BB2 CLM	50
	Lingual Brackets	51
	CLB	54
	Tube type appliance	60
	MTA	62
<b>* Archwires</b>	BB4 NiTi Archwire	54
	BB2 Archwire	60
<b>* Mini implants</b>	OrthAnchor	62
	Mini Screw	66
	e-Drvier	68
<b>* Buccal tubes</b>	MAJESTY Tube	74
	SM Tube	75
<b>* Accessories</b>	Extraoral appliance	76
	BK Mask	77
	Face Mask	78
	Intraoral appliance	79
	Orchestra Pack	80
	Elastomerics	81
	BB2 O-ring	84
	BB2 Chain	85
	Elastic Thread	86
	CLB O-ring	81
	CLB Power chain	81
	Interproximal reducer	84
	Perforated strip	85
	Reducer strip	86
	Accessories	81
	KS Lock	84
	Crimpable Hook	85
	Lingual Sheath	86
	Rolled Ligature Wire	81
	Anaper Wax	84
	Dentiform	85
	Resin Attachment	86
	Brackets bulk case	81
<b>* Instruments</b>	MAJESTY Debonding pliers	84
	MAJESTY Opener	85
	YES Opener	86
	Step Bend Pliers	81
	Wire Pusher	84
	Forced Positioner	85

## About us



**OSSTEM ORTHODONTICS Inc.** (formerly HUBIT Co., Ltd.) is an orthodontic manufacturer in Korea. We advocate human well-being by supporting dentists in providing excellent treatment service to their patients.

Since 2005, We supply the best quality products, the most efficient clinical technologies, and the best service to orthodontic specialists. Furthermore, we facilitate continuous R&D in the dental industry and dedicate our efforts for the finest dental health as well as patients' happiness with exclusive manufacturing technology.

In recognition of its value, HUBIT was acquired by OSSTEM IMPLANT in 2017, and the company name was changed to OSSTEM ORTHODONTICS in 2021. In the name of OSSTEM, we conform the R&D and quality standard as OSSTEM Implant does. Best quality products and expert employees are all strongly oriented to help orthodontists achieve the utmost treatment needed.

### \* Our Working Culture

Our Corporate culture is derived from the people that create it. Our people are at the heart of our business strategy and success. We focus on equal employment opportunity, diversity, and inclusion in our recruitment process, making sure we attract candidates from all backgrounds, traditional and non-traditional. We provide our people with a variety of tools—enriching professional experiences, daily coaching, and productive feedback—to help them make their professional lives productive and enjoyable.

### \* Our Corporate Purpose

Our values and behaviors define the expectations we have for working together and with our clients. Although we come from different backgrounds and cultures across the firm, they are what we all have in common. They capture our shared aspirations and expectations and guide how we make decisions and treat others. As OSSTEM professionals, we align our actions with the values and behaviors of OSSTEM. We think about the values as a full set – all are equally critical to our success.

**We act with integrity and speak up for the truth, even when that's the harder option.**

#### ■ We care about our employees.

We care for each other and we highly value our clients as we empower everyone to do their best.

#### ■ We work together as one and we listen to feedback.

Harmonious collaboration and diverse perspectives make our work stronger.

#### ■ We create the possible.

At OSSTEM ORTHODONTICS, we innovate, we test, we integrity and we learn along the way.

## History

Launched "MAJESTY SLC Ceramic Self-ligating Bracket" 05  
Held 3rd HUBIT forum through on-line 10



Joined OSSTEM IMPLANT Group 08

Launched "CHOIS Lingual Bracket" 01  
Launched "OK Bracket" 01



Received the Million Dollars Export Award

Established R&D center 01

Launched PERFECT CLEAR 1 12



2021

03 Company name changed to "OSSTEM ORTHODONTICS"  
03 Launched "MAJESTY SLM Metal Self-ligating Bracket"

2020



2017

07 CIM factory opened  
10 Held 1st HUBIT forum (Ask experts)

2016

2013

08 Launched "YES Bracket"



2012

2011

03 Launched "Tri-Edge Sapphire Bracket"  
07 Launched "MTA Tube Wire"  
11 Launched "MTA Tube"

2010

2009

02 Acquired NMPA(SFDA)  
11 Recognized as INNOBIZ company

2008

2007

02 Acquired ISO 13485 & EC Certificate

2006

2005

03 Establishment of HUBIT Co., Ltd.  
06 Acquired Medical Device Manufacturing License  
10 Acquired KGMP



## Brackets

---



# OSSTEM ORTHODONTICS SOLUTION

## PRODUCT CATALOGUE

* Brackets	Self-Ligating Brackets	MAJESTY Ceramic	08
		MAJESTY Metal	14
		YES	19
Aesthetic Brackets		Perfect Clear	23
		Perfect Clear 2	28
		OK Real Resin Bracket	34
Metal Brackets		BB2 CLM	38
Lingual Brackets		CLB	41
Tube type appliance		MTA	44

Ceramic Self ligating brackets

# MAJESTY Ceramic



MAJESTY Ceramic was designed and manufactured with precise engineering and accuracy to allow for the precise tooth movement orthodontists intend for their patients.

The ceramic injection molding technology with elaborated aesthetic white color body provides patient-pleasing comfort and beauty. Furthermore, MAJESTY Ceramic brackets cover all teeth, from anterior tooth to premolars.

- Heat-treated ceramic body fully applicable on shear or tensile force.
- Rounded corner designed for patient comfort and aesthetic purposes.
- Push or Pull clip mechanism allow for more ways to use MAJESTY. Heat-treated clips sustain hardness during the treatment.
- Rhodium-coated metal clip shade.
- Metallic shine provides harmonized beauty.
- Tension-improved clip enables stable elasticity during treatment.

Hook strength test

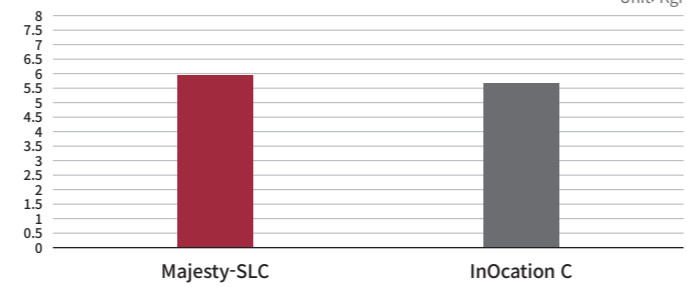

Wing strength test

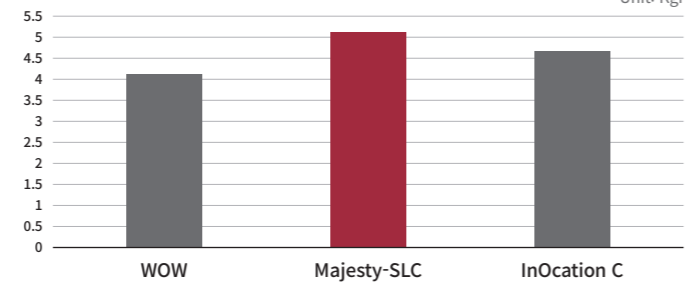

OSSTEM MAJESTY				Others				in-Ovation C				
HRC	1	2	3	1	2	3	1	2	3	1	2	3
Sample 1	56.5	58.4	58	54	53.9	54.9	56.1	58.6	61.1	56.1	58.6	61.1
Sample 2	57.5	56.3	59.3	54.7	55.1	54.3	60.4	59.2	57.8	60.4	59.2	57.8
Sample 3	56.9	57.2	58.8	56.9	52.8	56.5	61.4	59.4	61.1	61.4	59.4	61.1

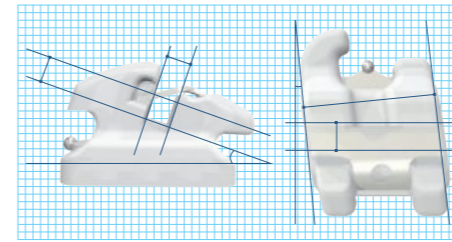

- Micrometer level of precision manufacturing mimics tooth movement intended by doctors.
- Optimum mesial-distal width for exceptional rotational control and orthodontic force for balanced treatment.
- All manufacturing process follow Osstem Implant Manufacturing Standards.

- Lower profile and minimized in/out designed wire slot ensures accurate orthodontic treatment and patient comfort.
- Enough space tie-wing design supports doctor's daily manipulation.
- Rounded slot bottom design reinforces durability of the bracket slot.

Slot durability test of wire's torque play

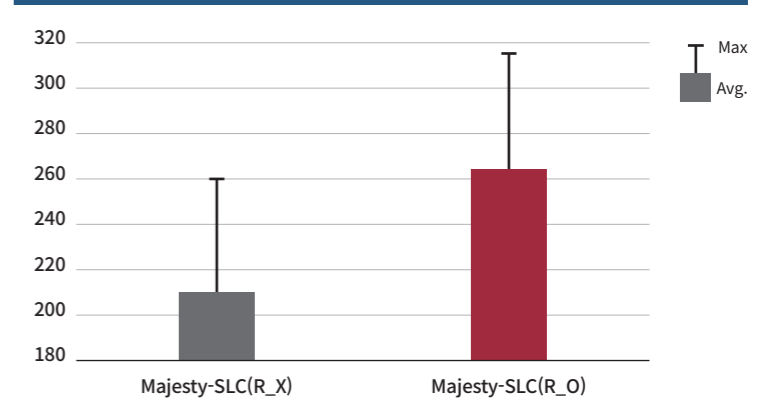

- Pattern mold and alumina-coated Dual Bonding System provide enhanced bonding strength until the end of treatment.
- Improved bonding power sustains every axis of force.

- 3D curvature designed base to accurate fit on tooth surface.
- MAJESTY Ceramic provides enough bonding strength-mechanically and chemically.
- The strong bonding and 3D curved design enable the braces to perform until the end of treatment.



**\* MAJESTY Open tool**

MAJESTY opener allow for easy opening and keep clip's performance with minimized deformation risk (patented).

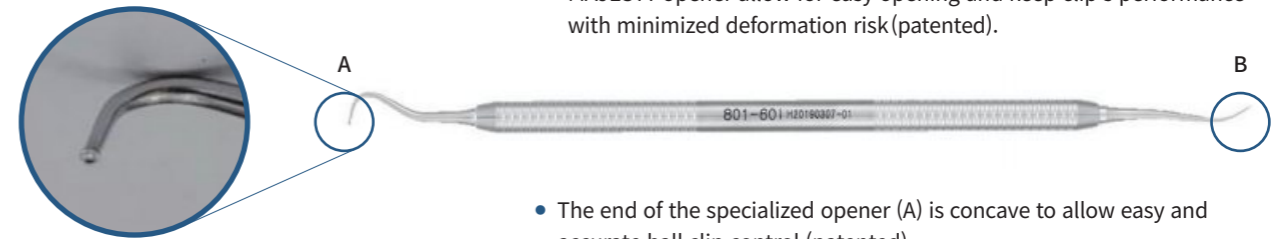

- The end of the specialized opener (A) is concave to allow easy and accurate ball clip control (patented).

**\* Bracket shift self-ligating system with wire sequence**

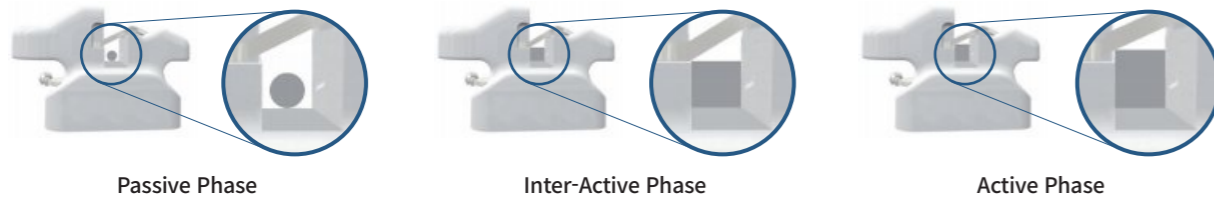

- Enhanced durability of the bracket body.
- Upgraded ceramic injection molding process with heat treatment processing to reduced fracture risk.

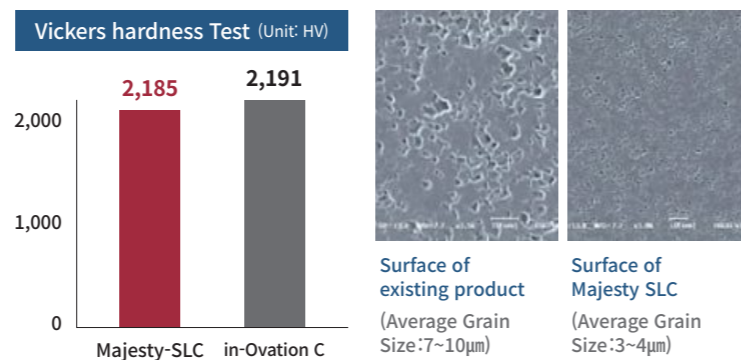

- Pattern mold and alumina coated base design provide improved bonding strength at any axis of force.
- Bond strength sustains performance until the end of treatment.

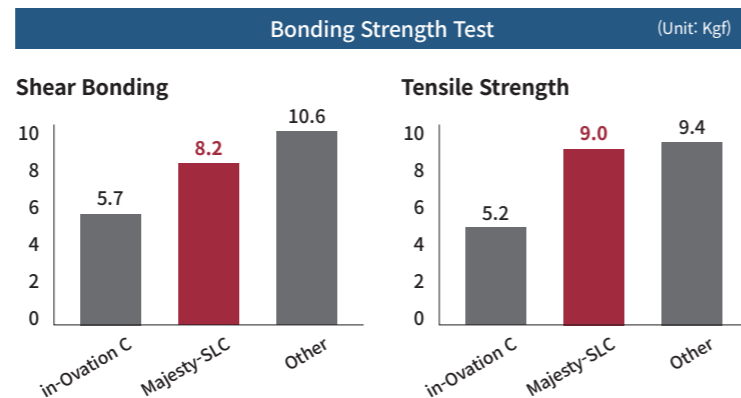

**\* Bracket debonding tool, the best fit for MAJESTY Ceramic**

- OSSTEM ORTHODONTICS delivers a debonding protocol to debond MAJESTY Ceramic brackets without tooth damage and pain.
- We recommend using the Majesty debonding plier for best fit. Please follow debonding guide steps 1 to 3 described below.
- The newly designed instruments are specially calibrated to fit the profile and base of the ceramic brackets, resulting on a fast and comfortable experience.

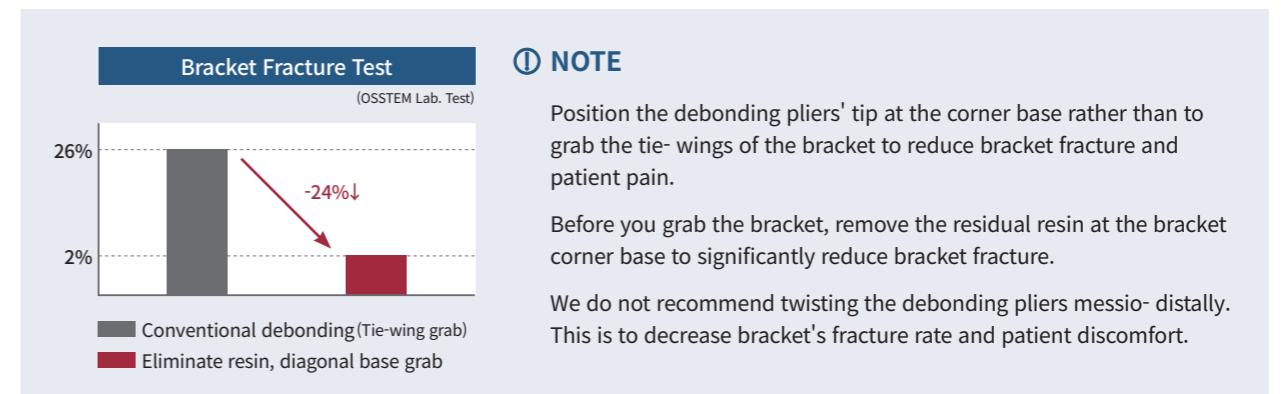
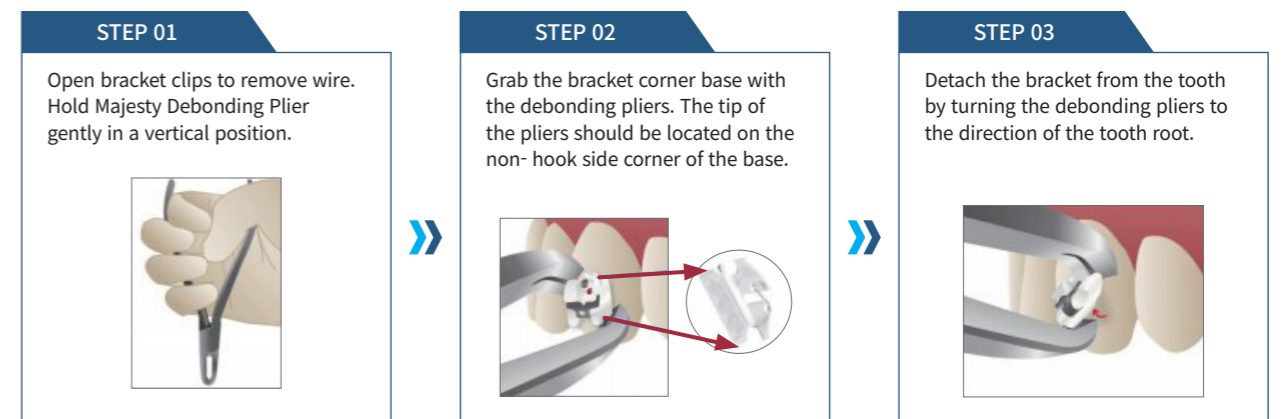

**NOTE**

Position the debonding pliers' tip at the corner base rather than to grab the tie-wings of the bracket to reduce bracket fracture and patient pain.

Before you grab the bracket, remove the residual resin at the bracket corner base to significantly reduce bracket fracture.

We do not recommend twisting the debonding pliers mesio-distally. This is to decrease bracket's fracture rate and patient discomfort.

✳ ROTH Prescription

ROTH prescription can be organized by SLC (anterior, cuspid) and SLM for bicuspid together

Maxillary

Tooth	Torque	Angle	M-D	.018"		.022"	
				R	L	R	L
1 Central	+12°	+5°	3.40	M-100-11-5	M-100-21-5	M-110-11-5	M-110-21-5
2 Lateral	+8°	+9°	3.20	M-100-12-5	M-100-22-5	M-110-12-5	M-110-22-5
3 Cuspid with Hook	-2°	+8°	3.40	M-100-13H-5	M-100-23H-5	M-110-13H-5	M-110-23H-5
4 Bicuspid with Hook	-7°	0°	3.40	SLC: M-100-14H-5	SLC: M-100-24H-5	SLC: M-110-14H-5	SLC: M-110-24H-5
	-7°	0°	3.00	SLM: 107-14H-5	SLM: 107-24H-5	SLM: 117-14H-5	SLM: 117-24H-5
5 Bicuspid with Hook	-7°	0°	3.40	SLC: M-100-15H-5	SLC: M-100-25H-5	SLC: M-110-15H-5	SLC: M-110-25H-5
	-7°	0°	3.00	SLM: 107-15H-5	SLM: 107-25H-5	SLM: 117-15H-5	SLM: 117-25H-5

Mandibular

Tooth	Torque	Angle	M-D	.018"		.022"	
				R	L	R	L
1 Central	-1°	2°	3.00	M-100-41-5	M-100-31-5	M-110-41-5	M-110-31-5
2 Lateral	-1°	2°	3.00	M-100-42-5	M-100-32-5	M-110-42-5	M-110-32-5
3 Cuspid with Hook	-11°	+7°	3.40	M-100-43H-5	M-100-33H-5	M-110-43H-5	M-110-33H-5
4 Bicuspid with Hook	-17°	-1°	3.40	SLC: M-100-44H-5	SLC: M-100-34H-5	SLC: M-110-44H-5	SLC: M-110-34H-5
	-17°	-1°	3.00	SLM: 107-44H-5	SLM: 107-34H-5	SLM: 117-44H-5	SLM: 117-34H-5
5 Bicuspid with Hook	-22°	-1°	3.40	SLC: M-100-45H-5	SLC: M-100-35H-5	SLC: M-110-45H-5	SLC: M-110-35H-5
	-22°	-1°	3.00	SLM: 107-45H-5	SLM: 107-35H-5	SLM: 117-45H-5	SLM: 117-35H-5

Single patient kit

Patient Kit	Cuspid Bicuspid hook		Cuspid hook	
	.018"	.022"	.018"	.022"
Upper Lower 5*5	106-553	116-553		
Upper 5*5	106-503	116-503		
Lower 5*5	106-053	116-053		
Upper Lower 3*3			106-331	116-331
Upper 3*3			106-301	116-301
Lower 3*3			106-031	116-031
SLC 3*3+ SLM 4-5(U/L)	106-331M	116-331M		
SLC 5*3+ SLM 4-5(L)	106-533M	116-533M		

Brackets identification

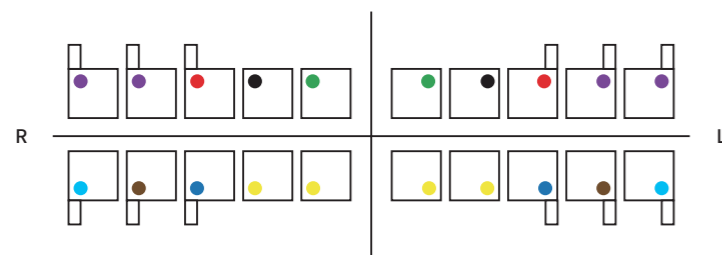

✳ MBT Prescription

MBT prescription can be organized by SLC (anterior, cuspid) and SLM for bicuspid together

Maxillary

Tooth	Torque	Angle	M-D	.022"	
				R	L
1 Central	+17°	+4°	3.40	M-130-11-5	M-130-21-5
2 Lateral	+10°	+8°	3.20	M-130-12-5	M-130-22-5
3 Cuspid with Hook	0°	+8°	3.40	M-130-13H-5	M-130-23H-5
4 Bicuspid with Hook	-7°	0°	3.40	SLC: M-130-14H-5	SLC: M-130-24H-5
	-7°	0°	3.00	SLM: 137-14H-5	SLM: 137-24H-5
5 Bicuspid with Hook	-7°	0°	3.40	SLC: M-130-15H-5	SLC: M-130-25H-5
	-7°	0°	3.00	SLM: 137-15H-5	SLM: 137-25H-5

Mandibular

Tooth	Torque	Angle	M-D	.022"	
				R	L
1 Central	0°	0°	3.00	M-130-41-5	M-130-31-5
2 Lateral	0°	0°	3.00	M-130-42-5	M-130-32-5
3 Cuspid with Hook	0°	+3°	3.40	M-130-43H-5	M-130-33H-5
4 Bicuspid with Hook	-12°	0°	3.40	SLC: M-130-44H-5	SLC: M-130-34H-5
	-12°	0°	3.00	SLM: 137-44H-5	SLM: 137-34H-5
5 Bicuspid with Hook	-17°	0°	3.40	SLC: M-130-45H-5	SLC: M-130-35H-5
	-17°	0°	3.00	SLM: 137-45H-5	SLM: 137-35H-5

Single patient kit

Patient Kit	Cuspid Bicuspid hook	Cuspid hook
	.022"	.022"
Upper Lower 5*5	136-553	
Upper 5*5	136-503	
Lower 5*5	136-053	
Upper Lower 3*3		136-331
Upper 3*3		136-301
Lower 3*3		136-031
SLC 3*3+ SLM 4-5(U/L)	136-331M	
SLC 5*3+ SLM 4-5(L)	136-533M	

Brackets identification

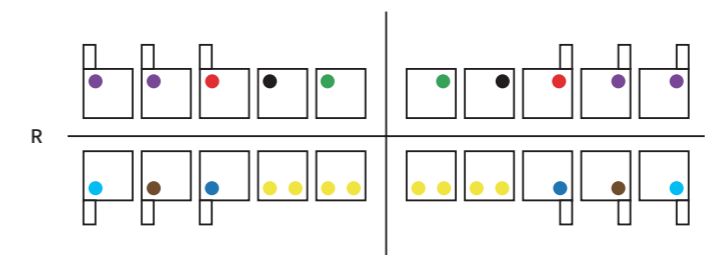

Metal Self-Ligating brackets

# MAJESTY Metal



MAJESTY Metal is designed and manufactured with precise engineering and accurate features to allow teeth to move precisely how orthodontists intend.

Metal injection molding technology and precise processing to make metal brackets with lower frictions.

- Bold design hook for easy ligation, but with angle and length carefully curated for less irritation.
- Push or pull clip mechanism to provide more options to doctors when using MAJESTY.
- Rounded Slot Entrance: Reduces friction from wire binding and is less visible.
- Modified Clip Shape: The hole on the clip is compatible with alternative open tool use.
- Thicker, more robust clip: 16% thicker and stronger than the previous generation. Increases wire seating force and reduces clip deformation.

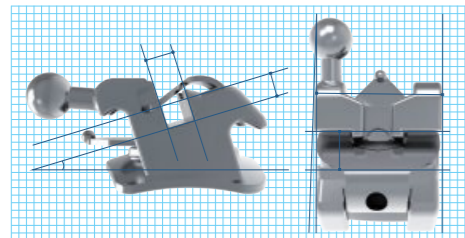

- Micrometer level of precision manufacturing mimics tooth movement intended by doctors.
- Optimum mesial-distal width for exceptional rotational control and orthodontic force for balanced treatment.

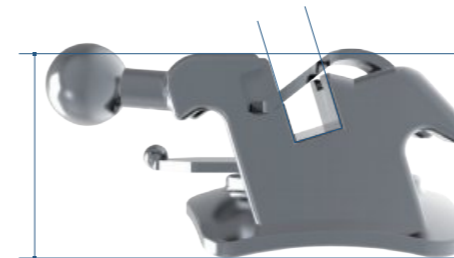

- Lower profile and minimized in/out wire slot design assures accurate orthodontic treatment with patient comfort.
- Precision processed slot has less friction than our prior metal brackets.

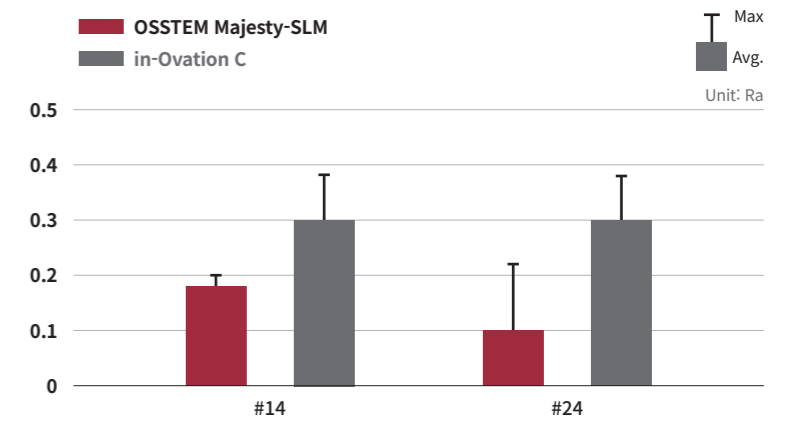

- 80-gauge mesh pad applied at a 45° angle.
- Anatomically contoured base surface.
- Laser marked FDI information making the brackets easily recognizable.

### \* Bracket shift self-ligating system with wire sequence

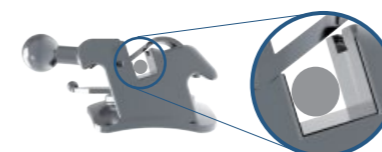

Passive Phase

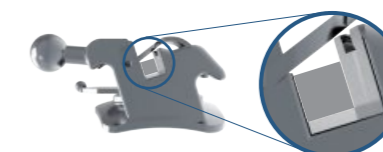

Inter-Active Phase  
020 x 020 (Rect.)

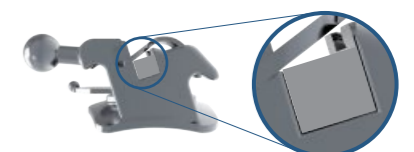

Active Phase



**\* MAJESTY Open tool**

MAJESTY opener allow for easy opening and keep clip's performance with minimized deformation risk (patented).

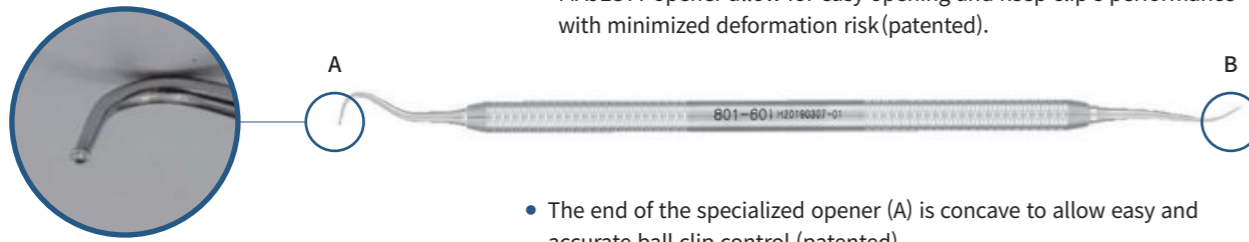

- The end of the specialized opener (A) is concave to allow easy and accurate ball clip control (patented).



Majesty Debonding Plier

**\* Bracket debonding tool, the best fit for MAJESTY Ceramic**

- OSSTEM ORTHODONTICS delivers a debonding protocol to debond MAJESTY Ceramic brackets without tooth damage and pain.
- We recommend using the Majesty debonding plier for best fit. Please follow debonding guide steps 1 to 3 described below.
- The newly designed instruments are specially calibrated to fit the profile and base of the ceramic brackets, resulting on a fast and comfortable experience.

**STEP 01**

Open bracket clips to remove wire. Hold Majesty Debonding Plier gently in a vertical position.

**STEP 02**

Grab the bracket corner base with the debonding pliers. The tip of the pliers should be located on the non-hook side corner of the base.

**STEP 03**

Detach the bracket from the tooth by turning the debonding pliers to the direction of the tooth root.

**Bracket Fracture Test**  
(OSSTEM Lab. Test)

26%  
2%  
-24%↓

■ Conventional debonding (Tie-wing grab)  
■ Eliminate resin, diagonal base grab

**NOTE**

Position the debonding pliers' tip at the corner base rather than to grab the tie- wings of the bracket to reduce bracket fracture and patient pain.

Before you grab the bracket, remove the residual resin at the bracket corner base to significantly reduce bracket fracture.

We do not recommend twisting the debonding pliers messio- distally. This is to decrease bracket's fracture rate and patient discomfort.

**\* ROTH Prescription**

**Maxillary**

Tooth	Torque	Angle	M-D	.018"		.022"	
				R	L	R	L
1 Central	+12°	+5°	3.00	107-11-5	107-21-5	117-11-5	117-21-5
2 Lateral	+8°	+9°	2.80	107-12-5	107-22-5	117-12-5	117-22-5
3 Cuspid with Hook	-2°	+1°	3.00	107-13H-5	107-23H-5	117-13H-5	117-23H-5
4 Bicuspid with Hook	-7°	0°	3.00	107-14H-5	107-24H-5	117-14H-5	117-24H-5
5 Bicuspid with Hook	-7°	0°	3.00	107-15H-5	107-25H-5	117-15H-5	117-25H-5

**Mandibular**

Tooth	Torque	Angle	M-D	.018"		.022"	
				R	L	R	L
1 Central	-1°	+2°	2.6	107-41-5	107-31-5	117-41-5	117-31-5
2 Lateral	-1°	+2°	2.6	107-42-5	107-32-5	117-42-5	117-32-5
3 Cuspid with Hook	-11°	+7°	3.00	107-43H-5	107-33H-5	117-43H-5	117-33H-5
4 Bicuspid with Hook	-17°	-1°	3.00	107-44H-5	107-34H-5	117-44H-5	117-34H-5
5 Bicuspid with Hook	-22°	-1°	3.00	107-45H-5	107-35H-5	117-45H-5	117-35H-5

**Single patient kit**

Patient Kit	Cuspid Bicuspid hook		Cuspid hook	
	.018"	.022"	.018"	.022"
Upper Lower 5*5	107-553	117-553		
Upper 5*5	107-503	117-503		
Lower 5*5	107-053	117-053		
Upper Lower 3*3			107-331	117-331
Upper 3*3			107-301	117-301
Lower 3*3			107-031	117-031

**Brackets identification**

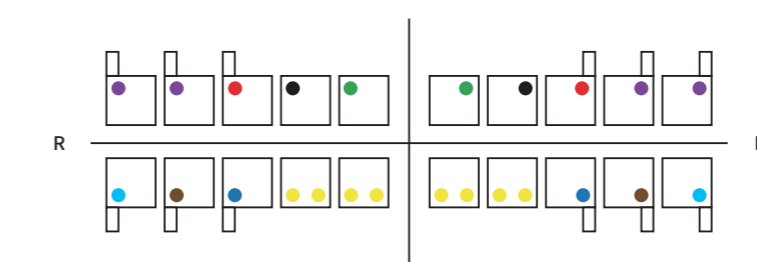

✳ **MBT Prescription**

MBT prescription can be organized by SLC (anterior, cuspid) and SLM for bicuspid together

**Maxillary**

Tooth	Torque	Angle	M-D	.022"	
				R	L
1 Central	+17°	+4°	3.00	137-11-5	137-21-5
2 Lateral	+10°	+8°	2.80	137-12-5	137-22-5
3 Cuspid with Hook	0°	+8°	3.00	137-13H-5	137-23H-5
4 Bicuspid with Hook	-7°	0°	3.00	137-14H-5	137-24H-5
5 Bicuspid with Hook	-7°	0°	3.00	137-15H-5	137-25H-5

**Mandibular**

Tooth	Torque	Angle	M-D	.022"	
				R	L
1 Central	-6°	0°	2.6	137-41-5	137-31-5
2 Lateral	-6°	0°	2.6	137-42-5	137-32-5
3 Cuspid with Hook	-6°	+3°	3.00	137-43H-5	137-33H-5
4 Bicuspid with Hook	-12°	+2°	3.00	137-44H-5	137-34H-5
5 Bicuspid with Hook	-17°	+2°	3.00	137-45H-5	137-35H-5

**Single patient kit**

Patient Kit	Cuspid Bicuspid hook	Cuspid hook
	.022"	.022"
Upper Lower 5*5	137-553	
Upper 5*5	137-503	
Lower 5*5	137-053	
Upper Lower 3*3		137-331
Upper 3*3		137-301
Lower 3*3		137-031

**Brackets identification**

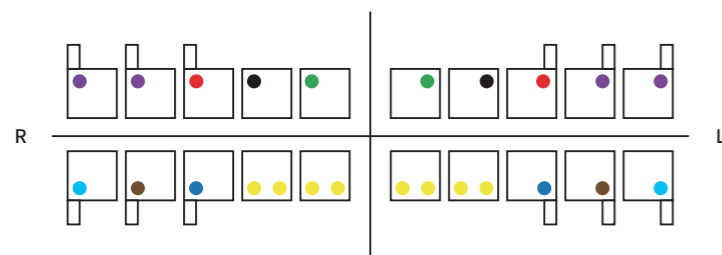

Metal Self-Ligating brackets

**YES**



The YES metal self-ligating bracket is designed and well-crafted for efficiency of treatment and patient comfort.

Mini size metal self-ligating bracket with active clip system improve orthodontic treatment periods and patient satisfaction.

- Pentagon base design provides a strong bonding strength and self-ligating clip protection.
- OSSTEM ORTHODONTICS mini metal self-ligating brackets YES is more comfortable for patients with its round edges at all features.
- Chamfered slot entrance: Brackets are sliding as following arch wire guide.
- Push or Pull clip mechanism to provide more compatible option to YES use.
- Hole on the clip to compatible with alternative open tool use.
- Vertically carved marking is parallel to the long axis of the clinical crown, the vertical line facilitates more accurate placement of each bracket on the long axis for bonding.
- Thicker, more robust clip: 16% thicker and stronger than the previous generation; increases wire seating force and reduces clip deformation.
- Mini-size profile and in/out designed wire slot ensures accurate orthodontic treatment and patient comfort.



- 80-gauge mesh pad applied at a 45° angle.
- Anatomically contoured base surface.
- Laser marked FDI information making the brackets easily recognizable.



\* Bracket shift self-ligating system with wire sequence

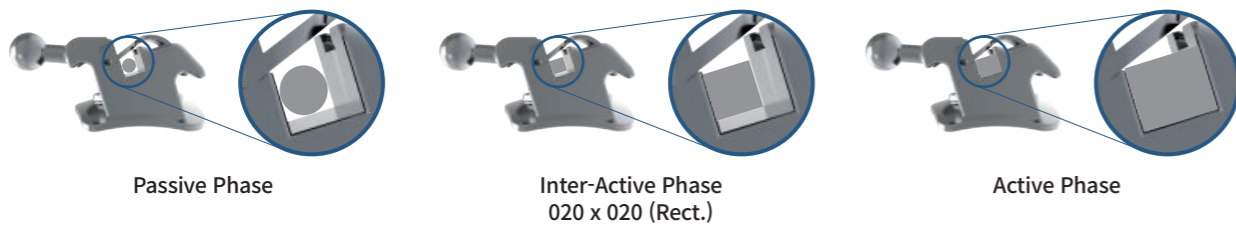

\* Best bracket open tool for YES

YES special open tools ensure easy opening and keep clip's performance with minimal deformation.

**Proper Opening**

1

Place the opener tip into the clip slot.

2

Tilt the opener gingivally as shown as picture 2.

3

Open

Gently open clip with finger pressure until the stopper tip is hooked.

**Wrong Openings**

**Wrong**

Do not place the opener tip deep inside the bracket slot.

**Wrong**

Do not use stopper tip to open the clip.

**Wrong**

Do not open the clip without tilting the opener gingivally.

**Closing (2 ways of closing)**

1

2

Close the clip after pressing the wire by using 1 finger or 2 wire pusher.

\* ROTH Prescription

Maxillary

Tooth	Torque	Angle	M-D	.022"	
				R	L
1 Central	+11°	+5°	2.90	113-11-5	113-21-5
2 Lateral	+8°	+9°	2.70	113-12-5	113-22-5
3 Cuspid with Hook	-2°	+8°	2.95	113-13H-5	113-23H-5
4 Bicuspid with Hook	-7°	0°	2.95	113-14H-5	113-24H-5
5 Bicuspid with Hook	-7°	0°	2.95	113-14H-5	113-24H-5

Mandibular

Tooth	Torque	Angle	M-D	.022"	
				R	L
1 Central	0°	0°	2.5	113-31-5	113-31-5
2 Lateral	0°	0°	2.5	113-31-5	113-31-5
3 Cuspid with Hook	-11°	+7°	2.95	113-43H-5	113-33H-5
4 Bicuspid with Hook	-17°	0°	2.95	113-44H-5	113-34H-5
5 Bicuspid with Hook	-17°	0°	2.95	113-44H-5	113-35H-5

Single patient kit

Patient Kit	Cuspid Bicuspid hook	Cuspid hook
	.022"	.022"
Upper Lower 5*5	113-553	
Upper 5*5	113-503	
Lower 5*5	113-053	
Upper Lower 3*3		113-331
Upper 3*3		113-301
Lower 3*3		113-031

Brackets identification

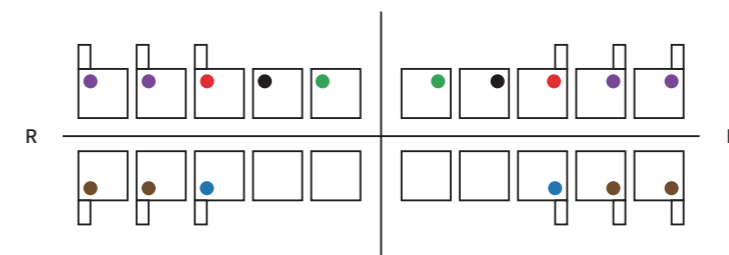

\* MBT Prescription

Maxillary

Tooth	Torque	Angle	M-D	.022"	
				R	L
1 Central	+17°	+ 4°	2.90	133-11-5	133-21-5
2 Lateral	+10°	+ 8°	2.70	133-12-5	133-22-5
3 Cuspid with Hook	0°	+ 8°	2.95	133-13H-5	133-23H-5
4 Bicuspid with Hook	-7°	0°	2.95	133-14H-5	133-24H-5
5 Bicuspid with Hook	-7°	0°	2.95	133-14H-5	133-24H-5

Mandibular

Tooth	Torque	Angle	M-D	.022"	
				R	L
1 Central	-6°	0°	2.5	133-31-5	133-31-5
2 Lateral	-6°	0°	2.5	133-31-5	133-31-5
3 Cuspid with Hook	0°	+3°	2.95	113-43H-5	113-33H-5
4 Bicuspid with Hook	-12°	0°	2.95	113-44H-5	113-34H-5
5 Bicuspid with Hook	-12°	0°	2.95	113-44H-5	113-35H-5

Single patient kit

Patient Kit	Cuspid Bicuspid hook	Cuspid hook
	.022"	.022"
Upper Lower 5*5	133-553	
Upper 5*5	133-503	
Lower 5*5	133-053	
Upper Lower 3*3		133-331
Upper 3*3		133-301
Lower 3*3		133-031

Brackets identification

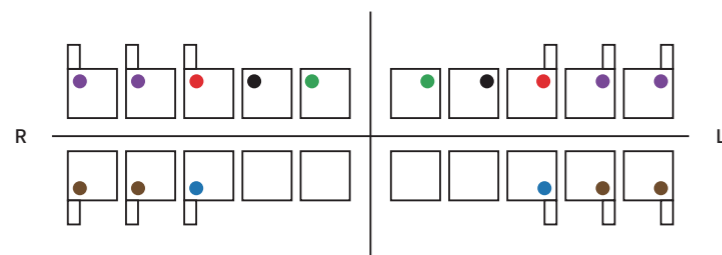

Sapphire tie-wing brackets

# Perfect Clear



Perfect Clear is the clearest ceramic twin bracket available, delivering exceptional results with features other cosmetic brackets just can't match. The Perfect Clear is stronger and even more dazzling than the previous generation, with a thicker, stronger tie-wing radius. Perfect Clear is manufactured from monocrystalline and is nearly invisible on teeth.



- Tie-wings are designed with a smooth radius on the base of each wing, significantly reducing fracture risk. An enlarged tie-wing undercut is featured for easier placement of elastics, ligatures, and chains. The decreased tie-wing thickness on each Perfect Clear 2 bracket enhances its solid body. This thicker space provides the appropriate dimensions to help decrease fracture risk and help with effective tying.



- Comfort radius with rounded corners and dome-shaped profile to fit comfortably inside the mouth.
- Lowest profiles to enhance patient comfort and minimize occlusal interference.



- Rounded corners in the slot to minimize binding and notching.
- Generous under tie-wing area to accommodate easy ligation and double ligation.
- Optimum mesial-distal width for exceptional rotational control.

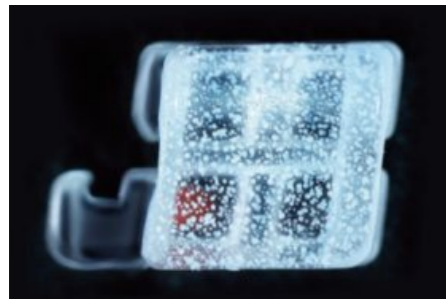

- Alumina-coated base delivers a strong bond and thicker tie-wings for reduced bracket failure.
- This technology delivers a strong bond in the center of the bracket and a smooth perimeter to make the debonding process predictable and simple.
- Proprietary stress concentrator for predictable squeeze debonding.



- A heat-treated, monocrystalline formation gives Perfect Clear a solid core structure, as opposed to the strand structure found in polycrystalline brackets. A proprietary heat polishing process creates just enough energy to smooth out any micro-voids or flaws that could compromise the bracket's integrity. This helps improve sliding mechanics and results in a bracket that resists torque fracture more than three times that of polycrystalline brackets.

✳ ROTH Prescription

Maxillary

Tooth	Torque	Angle	M-D	.018"		.022"	
				R	L	R	L
1 Central	+11°	+5°	3.20	300-11-5	300-21-5	310-11-5	310-21-5
2 Lateral	+8°	+9°	2.95	300-12-5	300-22-5	310-12-5	310-22-5
3 Cuspid	-2°	+8°	3.50	300-13-5	300-23-5	310-13-5	310-23-5
				300-13H-5	300-23H-5	310-13H-5	310-23H-5
4 Bicuspid	-7°	0°	3.20	300-14-5	300-24-5	310-14-5	310-24-5
				300-14H-5	300-24H-5	310-14H-5	310-24H-5
5 Bicuspid	-7°	0°	3.20	300-14-5	300-24-5	310-14-5	310-24-5
				300-14H-5	300-24H-5	310-14H-5	310-24H-5

Mandibular

Tooth	Torque	Angle	M-D	.018"		.022"	
				R	L	R	L
1 Central	0°	0°	2.85	300-31-5	300-31-5	310-31-5	310-31-5
2 Lateral	0°	0°	2.85	300-31-5	300-31-5	310-31-5	310-31-5
3 Cuspid	-11°	+7°	3.5	300-43-5	300-33-5	310-43-5	310-33-5
				300-43H-5	300-33H-5	310-43H-5	310-33H-5
4 Bicuspid	-17°	+3°	3.2	300-44-5	300-34-5	310-44-5	310-34-5
				300-44H-5	300-34H-5	310-44H-5	310-34H-5
5 Bicuspid	-21°	+6°	3.2	300-45-5	300-35-5	310-45-5	310-35-5
				300-45H-5	300-35H-5	310-45H-5	310-35H-5

Single patient kit

Patient Kit	Cuspid Bicuspid hook		Cuspid hook		non hook	
	.018"	.022"	.018"	.022"	.018"	.022"
Upper Lower 5*5	300-553	310-553	300-551	310-551	300-550	310-550
Upper 5*5	300-503	310-503	300-501	310-501	300-500	310-500
Lower 5*5	300-053	310-053	300-051	310-051	300-050	310-050
Upper Lower 3*3			300-331	310-331		
Upper 3*3			300-301	310-301		
Lower 3*3			300-031	310-031		

Brackets identification

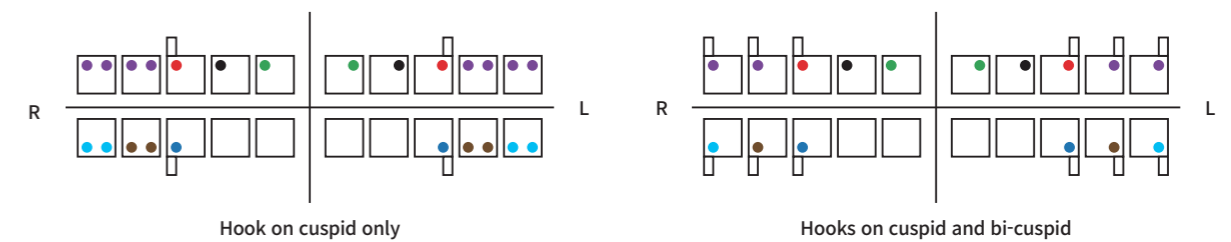

✳ MBT Prescription

Maxillary

Tooth	Torque	Angle	M-D	.018"		.022"	
				R	L	R	L
1 Central	+17°	+4°	3.20	320-11-5	320-21-5	330-11-5	330-21-5
2 Lateral	+10°	+8°	2.95	320-12-5	320-22-5	330-12-5	330-22-5
3 Cuspid	0°	+8°	3.50	320-13-5	320-23-5	330-13-5	330-23-5
				320-13H-5	320-23H-5	330-13H-5	330-23H-5
4 Bicuspид	-7°	0°	3.50	320-14-5	320-24-5	330-14-5	330-24-5
				320-14H-5	320-24H-5	330-14H-5	330-24H-5
5 Bicuspид	-7°	0°	3.20	320-14-5	320-24-5	330-14-5	330-24-5
				320-14H-5	320-24H-5	330-14H-5	330-24H-5

Mandibular

Tooth	Torque	Angle	M-D	.018"		.022"	
				R	L	R	L
1 Central	-6°	0°	2.85	320-31-5	320-31-5	330-31-5	330-31-5
2 Lateral	-6°	0°	2.85	320-31-5	320-31-5	330-31-5	330-31-5
3 Cuspid	0°	+3°	3.5	320-43-5	320-33-5	330-43-5	330-33-5
				320-43H-5	320-33H-5	330-43H-5	330-33H-5
4 Bicuspид	-12°	+2°	3.2	320-44-5	320-34-5	330-44-5	330-34-5
				320-44H-5	320-34h-5	330-44H-5	330-34H-5
5 Bicuspид	-17°	+2°	3.2	320-45-5	320-35-5	330-45-5	330-35-5
				320-45h-5	320-35h-5	330-45H-5	330-35H-5

Single patient kit

Patient Kit	Cuspid Bicuspид hook		Cuspid hook		non hook	
	.018"	.022"	.018"	.022"	.018"	.022"
Upper Lower 5*5	320-553	330-553	320-551	330-551	320-550	330-550
Upper 5*5	320-503	330-503	320-501	330-501	320-500	330-500
Lower 5*5	320-053	330-053	320-051	330-051	320-050	330-050
Upper Lower 3*3			320-331	330-331	320-330	330-330
Upper 3*3			320-301	330-301	320-300	330-300
Lower 3*3			320-031	330-031	320-030	330-030

Brackets identification

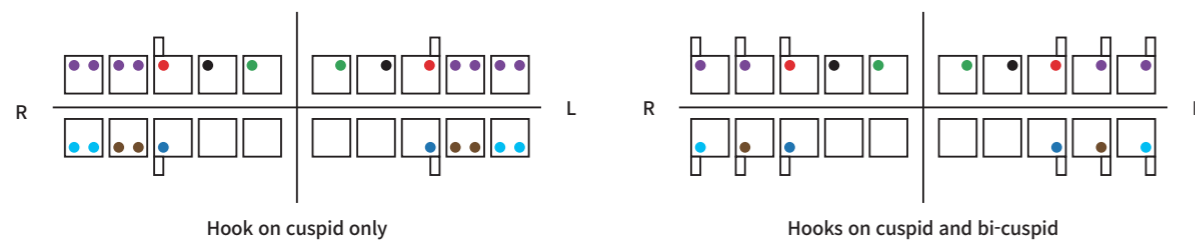

✳ Standard (Edgewise) Prescription

Maxillary

Tooth	Torque	Angle	M-D	.018"		.022"	
				R	L	R	L
1 Central	0°	0°	3.20	340-11-5	340-11-5	350-11-5	350-11-5
2 Lateral	0°	0°	3.00	340-12-5	340-12-5	350-12-5	350-12-5
3 Cuspid	0°	0°	3.50	340-13-5	340-13-5	350-13-5	350-13-5
				340-33H-5	340-43H-5	350-33H-5	350-43H-5
4 Bicuspид	0°	0°	3.20	340-14-5	340-14-5	350-14-5	350-14-5
5 Bicuspид	0°	0°	3.20	340-14-5	340-14-5	350-14-5	350-14-5

Mandibular

Tooth	Torque	Angle	M-D	.018"		.022"	
				R	L	R	L
1 Centrals	0°	0°	2.85	340-31-5	340-31-5	350-31-5	350-31-5
2 Laterals	0°	0°	2.85	340-31-5	340-31-5	350-31-5	350-31-5
3 Cuspid	0°	0°	3.5	340-13-5	340-13-5	350-13-5	350-13-5
				340-43H-5	340-33H-5	350-43H-5	350-33H-5
4 Bicuspид	0°	0°	3.2	340-14-5	340-14-5	350-14-5	350-14-5
5 Bicuspид	0°	0°	3.2	340-14-5	340-14-5	350-14-5	350-14-5

Single patient kit

Patient Kit	Cuspid hook		non hook	
	.018"	.022"	.018"	.022"
Upper Lower 5*5	340-551	350-551	340-550	350-550
Upper 5*5	340-501	350-501	340-500	350-500
Lower 5*5	340-051	350-051	340-050	350-050
Upper Lower 3*3	340-331	350-331	340-330	350-330
Upper 3*3	340-301	350-301	340-300	350-300
Lower 3*3	340-031	350-031	340-030	350-030

Brackets identification

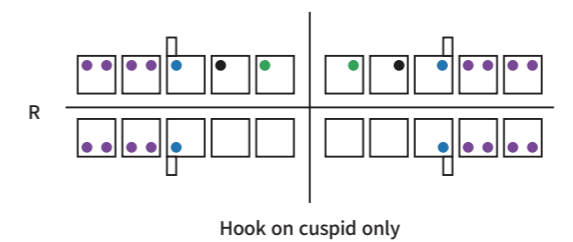

Sapphire tie-wing brackets

# Perfect Clear 2



Perfect Clear 2 is the clearest ceramic twin bracket available, delivering exceptional results with features other cosmetic brackets just can't match. The Perfect Clear 2 is stronger and even more dazzling than the previous generation, with a thicker, stronger tie-wing radius.

Perfect Clear 2 is manufactured from monocrystalline and is nearly invisible on teeth.



- Tie-wings are designed with a smooth radius on the base of each wing, significantly reducing fracture risk. An enlarged tie-wing undercut is featured for easier placement of elastics, ligatures, and chains. The decreased tie-wing thickness on each Perfect Clear 2 bracket enhances its solid body. This thicker space provides the appropriate dimensions to help decrease fracture risk and help with effective tying.



- Comfort radius with rounded corners and dome-shaped profile to fit comfortably inside the mouth.
- Lowest profiles to enhance patient comfort and minimize occlusal interference.



- Rounded corners in the slot to minimize binding and notching.
- Generous under tie-wing area to accommodate easy ligation and double ligation.
- Optimum mesial-distal width for exceptional rotational control.



- Alumina-coated base delivers a strong bond and thicker tie-wings for reduced bracket failure.
- This technology delivers a strong bond in the center of the bracket and a smooth perimeter to make the debonding process predictable and simple.
- Proprietary stress concentrator for predictable squeeze debonding.



- A heat-treated, monocrystalline formation gives Perfect Clear 2 a solid core structure, as opposed to the strand structure found in polycrystalline brackets. A proprietary heat polishing process creates just enough energy to smooth out any micro-voids or flaws that could compromise the bracket's integrity. This helps improve sliding mechanics and results in a bracket that resists torque fracture more than three times that of polycrystalline brackets.
- Perfect Clear 2 provides various shapes of brackets to support doctor's daily practice.



Friction test records

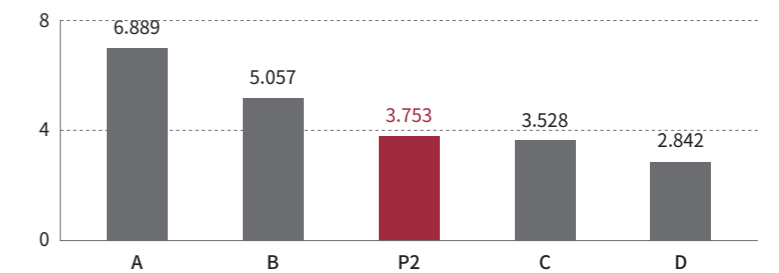

Fracture resistance test records

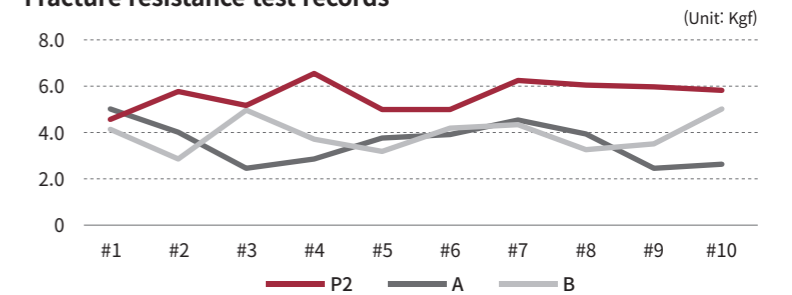

Torque(°)	11	12	13(H)	14/15(H)	21	22	23(H)	24/25(H)	31/32/41/42	33(H)	34(H)	13(H)	43(H)	44(H)	45(H)
ROTH	+11	+8	-2	-7	+11	+8	-2	-7	0	-11	-17	-21	-11	-17	-21
MBT	+17	+10	0	-7	+17	+10	0	-7	-6	0	-12	-17	0	-12	-17
STD(Edgewise)	0	0	0	0	0	0	0	0	0	0	0	0	0	0	0
High Torque	+22	+13	+11		+22	+13	+11								

- High Torque: Doctors could choose a 'high torque' prescription for a patient with a possible collapse on their maxillary anterior tooth.
- Tri-Edge: 'Tri-edge' shaped brackets designed for the patient who has severely crowded occlusion to avoid brackets' interference.



- Optional hook: Perfect Clear 2 brackets provide distal hook options for every cuspids and bi-cuspids; doctors could choose the best brackets to fit your patient treatment.

✳ ROTH Prescription

Maxillary

Tooth	Torque	Angle	M-D	.018"		.022"	
				R	L	R	L
1 Central	+11°	+5°	3.20	200-11-5	200-21-5	210-11-5	210-21-5
2 Lateral	+8°	+9°	2.95	200-12-5	200-22-5	210-12-5	210-22-5
3 Cuspid Cuspid with Hook	-2°	+8°	3.50	200-13-5	200-23-5	210-13-5	210-23-5
				200-13H-5	200-23H-5	210-13H-5	210-23H-5
4 Bicuspид Bicuspид with Hook	-7°	0°	3.20	200-14-5	200-24-5	210-14-5	210-24-5
				200-14H-5	200-24H-5	210-14H-5	210-24H-5
5 Bicuspид Bicuspид with Hook	-7°	0°	3.20	200-14-5	200-24-5	210-14-5	210-24-5
				200-14H-5	200-24H-5	210-14H-5	210-24H-5

Mandibular

Tooth	Torque	Angle	M-D	.018"		.022"	
				R	L	R	L
1 Central	0°	0°	2.85	200-31-5	200-31-5	210-31-5	210-31-5
2 Lateral	0°	0°	2.85	200-31-5	200-31-5	210-31-5	210-31-5
3 Cuspid Cuspid with Hook	-11°	+7°	3.5	200-43-5	200-33-5	210-43-5	210-33-5
				200-43H-5	200-33H-5	210-43H-5	210-33H-5
4 Bicuspид Bicuspид with Hook	-17°	0°	3.2	200-44A-5	200-34A-5	210-44A-5	210-34A-5
				200-44HA-5	200-34HA-5	210-44HA-5	210-34HA-5
5 Bicuspид Bicuspид with Hook	-21°	0°	3.2	200-45A-5	200-35A-5	210-45A-5	210-35A-5
				200-45HA-5	200-35HA-5	210-45HA-5	210-35HA-5

Single patient kit

Patient Kit	Cuspid Bicuspид hook		Cuspid hook		non hook	
	.018"	.022"	.018"	.022"	.018"	.022"
Upper Lower 5*5	200-553A	210-553A	200-551A	210-551A	200-550	210-550
Upper 5*5	200-503	210-503	200-501	210-501	200-500	210-500
Lower 5*5	200-053A	210-053A	200-051A	210-051A	200-050A	210-050A
Upper Lower 3*3			200-331	210-331	200-330	210-330
Upper 3*3			200-301	210-301	200-300	210-300
Lower 3*3			200-031	210-031	200-030	210-030

Brackets identification

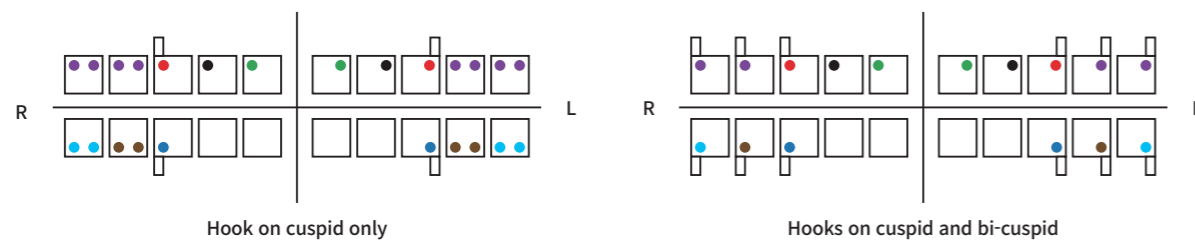

✳ MBT Prescription

Maxillary

Tooth	Torque	Angle	M-D	.018"		.022"	
				R	L	R	L
1 Central	+17°	+4°	3.20	220-11-5	220-21-5	230-11-5	230-21-5
2 Lateral	+10°	+8°	2.95	220-12-5	220-22-5	230-12-5	230-22-5
3 Cuspid Cuspid with Hook	0°	+8°	3.50	220-13H-5	220-23-5	230-13-5	230-23-5
				220-13H-5	220-23H-5	230-13H-5	230-23H-5
4 Bicuspид Bicuspид with Hook	-7°	0°	3.20	220-14-5	220-24-5	230-14-5	230-24-5
				220-14H-5	220-24H-5	230-14H-5	230-24H-5
5 Bicuspид Bicuspид with Hook	-7°	0°	3.20	220-14-5	220-24-5	230-14-5	230-24-5
				220-14H-5	220-24H-5	230-14H-5	230-24H-5

Mandibular

Tooth	Torque	Angle	M-D	.018"		.022"	
				R	L	R	L
1 Central	-6°	0°	2.85	220-31-5	220-31-5	230-31-5	230-31-5
2 Lateral	-6°	0°	2.85	220-31-5	220-31-5	230-31-5	230-31-5
3 Cuspid Cuspid with Hook	0°	+3°	3.5	220-43-5	220-33-5	230-43-5	230-33-5
				220-43H-5	220-33H-5	230-43H-5	230-33H-5
4 Bicuspид Bicuspид with Hook	-12°	+2°	3.2	220-44-5	220-34-5	230-44-5	230-34-5
				220-44H-5	220-34H-5	230-44H-5	230-34H-5
5 Bicuspид Bicuspид with Hook	-17°	+2°	3.2	220-45-5	220-35-5	230-45-5	230-35-5
				220-45H-5	220-35H-5	230-45H-5	230-35H-5

Single patient kit

Patient Kit	Cuspid Bicuspид hook		Cuspid hook		non hook	
	.018"	.022"	.018"	.022"	.018"	.022"
Upper Lower 5*5	220-553	230-553	220-551	230-551	220-550	230-550
Upper 5*5	220-503	230-503	220-501	230-501	220-500	230-500
Lower 5*5	220-053	230-053	220-051	230-051	220-050	230-050
Upper Lower 3*3			220-331	230-331	220-330	230-330
Upper 3*3			220-301	230-301	220-300	230-300
Lower 3*3			220-031	230-031	220-030	230-030

Brackets identification

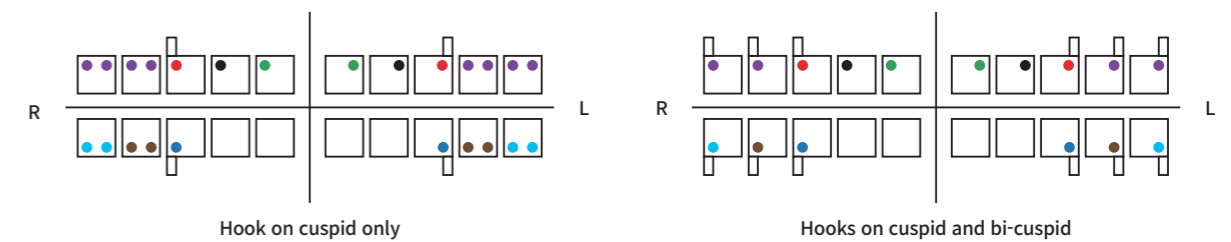



✳ Standard(Edgewise) Prescription

Maxillary

Tooth	Torque	Angle	M-D	.018"		.022"	
				R	L	R	L
1 Central	0°	0°	3.20	240-11-5	240-11-5	250-11-5	250-11-5
2 Lateral	0°	0°	3.00	240-12-5	240-12-5	250-12-5	250-12-5
3 Cuspid Cuspid with Hook	0°	0°	3.50	240-13-5	240-13-5	250-13-5	250-13-5
	0°	0°		240-33H-5	240-43H	250-33H-5	250-43H-5
4 Bicuspid	0°	0°	3.20	240-14-5	240-14-5	250-14-5	250-14-5
5 Bicuspid	0°	0°		240-14-5	240-14-5	250-14-5	250-14-5

Mandibular

Tooth	Torque	Angle	M-D	.018"		.022"	
				R	L	R	L
1 Centrals	0°	0°	2.85	240-31-5	240-31-5	250-31-5	240-31-5
2 Laterals	0°	0°	2.85	240-31-5	240-31-5	250-31-5	250-31-5
3 Cuspid Cuspid with Hook	0°	0°	3.5	240-13-5	240-13-5	250-13-5	250-13-5
	0°	0°		240-33H-5	240-43H-5	250-43H-5	250-33H-5
4 Bicuspid	0°	0°	3.2	240-14-5	240-14-5	250-14-5	250-14-5
5 Bicuspid	0°	0°		240-14-5	240-14-5	250-14-5	250-14-5

Single patient kit

Patient Kit	Cuspid hook		non hook	
	.018"	.022"	.018"	.022"
Upper Lower 5*5	240-551	250-551	240-550	250-550
Upper 5*5	240-501	250-501	240-500	250-500
Lower 5*5	240-051	250-051	240-050	250-050
Upper Lower 3*3	240-331	250-331	240-330	250-330
Upper 3*3			240-300	250-300
Lower 3*3			240-030	250-030

Brackets identification

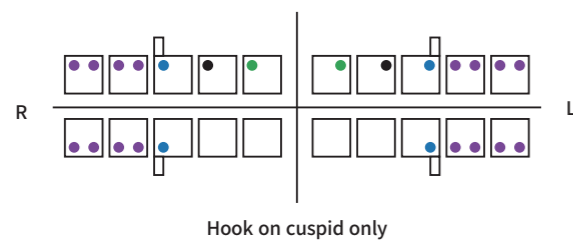

✳ Tri-Edge ROTH Prescription

Mandibular

Tooth	Torque	Angle	M-D	.018"		.022"	
				R	L	R	L
3 Cuspid with Hook	-11°	+7°	3.5	200-43HT-5	200-33HT-5	210-43HT-5	210-33HT-5
4 Bicuspid	-17°	3°	3.2	200-44T-5	200-34T-5	210-44T-5	210-34T-5
5 Bicuspid	-21°	6°	3.2	200-45T-5	200-35T-5	320-45T-5	210-35T-5

Single patient kit

Patient Kit	Cuspid hook	
	.018"	.022"
Upper Lower 3*3	200-331T	210-331T
Upper Lower 5*5	200-551T	210-551T

✳ Tri-Edge MBT Prescription

Mandibular

Tooth	Torque	Angle	M-D	.018"		.022"	
				R	L	R	L
3 Cuspid with Hook	0°	+3°	3.5	220-43HT-5	220-33HT-5	230-43HT-5	230-33HT-5
4 Bicuspid	-12°	+2°	3.2	220-44T-5	220-34T-5	230-44T-5	230-34T-5
5 Bicuspid	-17°	+2°	3.2	220-45T-5	220-34T-5	230-45T-5	230-34T-5

Single patient kit

Patient Kit	Cuspid hook	
	.018"	.022"
Upper Lower 3*3	220-331T	230-331T
Upper Lower 5*5	220-551T	230-551T

✳ Tri-Edge Standard Prescription

Mandibular

Tooth	Torque	Angle	M-D	.018"		.022"	
				R	L	R	L
3 Cuspid with Hook	0°	0°	3.1	240-43HT-5	240-33HT-5	250-43HT	250-33HT-5
4 Bicuspid	0°	0°	2.8	340-34T	340-34T	250-34T-5	250-34T-5
5 Bicuspid	0°	0°	2.8	340-34T	340-34T	250-34T-5	250-34T-5

Single patient kit

Patient Kit	Cuspid hook	
	.018"	.022"
Upper Lower 3*3	240-331T	250-331T
Upper Lower 5*5	240-551T	250-551T

✳ High Torque Prescription

Maxillary

Tooth	Torque	Angle	M-D	.022"	
				R	L
1 Central	+22°	+5°	3.2	270-11-5	270-21-5
2 Lateral	+13°	+9°	2.95	270-12-5	270-22-5
3 Cuspid with Hook	+11°	+8°	3.5	270-13H-5	270-23H-5

Single patient kit

Patient Kit	Cuspid hook	
	.022"	
Upper 3*3	270-301	

Resin tie-wing brackets

# OK Real resin



OK Real resin bracket's metal slot insert is designed to lower friction as the wire touches the insert only at four small points at the polymeric wall. The steel in the slot is designed to translate the torque through the base without the usual distortion or give off the plastic and other polymeric materials. Unlike inserts, which only line the slot wall, OK Real resin slot is placed within the body to strengthen the entire bracket, not just the slot. This placement also conceals the steel insert, creating a more esthetic appearance. OK can be utilized with any archwire. However, for a total aesthetic solution application, we recommend BB4 Esthetic Wires.



- Medical-grade polycarbonate material.
- Selected material provides a transparent and durable bracket hook and body.
- Stainless steel slot designed the same function as metal brackets.
- Easy recognizable the slot position and width for simple and accurate positioning.
- Less visible metal slot by BB4 NiTi aesthetic archwire use.
- Micrometer level of precision manufacturing enables tooth movement intended by doctors.
- Precise torque and angle controlled by precise engineering.
- Optimum mesial-distal width for exceptional rotational control and orthodontic force balanced treatment.



- Dove-tail shaped base design allows sufficient bonding strength.
- Tooth-specific base geometry and compound contour base design for precise tooth fitting.
- Enough space tie wing design to support doctor's everyday manipulation.

## \* ROTH Prescription

### Maxillary

Tooth	Torque	Angle	M-D	.018"		.022"	
				R	L	R	L
1 Central	+11°	+5°	3.50	600-11-5	600-21-5	610-11-5	610-21-5
2 Lateral	+8°	+9°	3.25	600-12-5	600-22-5	610-12-5	610-22-5
3 Cuspid with Hook	+2°	+8°	3.80	600-13H-5	600-23H-5	610-13H-5	610-23H-5
4 Bicuspid	+7°	0°	3.50	600-14-5	600-24-5	610-14-5	610-24-5
5 Bicuspid	+7°	0°	3.50	600-14-5	600-24-5	610-14-5	610-24-5

### Mandibular

Tooth	Torque	Angle	M-D	.018"		.022"	
				R	L	R	L
1 Central	0°	0°	3.15	600-31-5	600-31-5	610-31-5	610-31-5
2 Lateral	0°	0°	3.15	600-31-5	600-31-5	610-31-5	610-31-5
3 Cuspid with Hook	+11°	+7°	3.80	600-43H-5	600-33H-5	610-43H-5	610-33H-5
4 Bicuspid	+17°	0°	3.50	600-44-5	600-34-5	610-44-5	610-34-5
5 Bicuspid	-22°	0°	3.50	660-45-5	660-35-5	670-45-5	670-35-5

### Single patient kit

Patient Kit	Cuspid hook	
	.018"	.022"
Upper Lower 5*5	660-551	670-551
Upper 5*5	600-501	610-501
Lower 5*5	660-051	670-051
Upper Lower 3*3	600-331	610-331
Upper 3*3	600-301	610-301
Lower 3*3	600-031	610-031

### Brackets identification

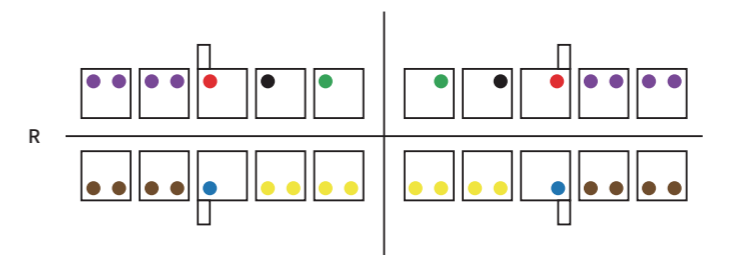

✳ MBT Prescription

Maxillary

Tooth	Torque	Angle	M-D	.018"		.022"	
				R	L	R	L
1 Central	+17°	+4°	3.50	620-11-5	620-21-5	630-11-5	630-21-5
2 Lateral	+10°	+8°	3.25	620-12-5	620-22-5	630-12-5	630-22-5
3 Cuspid with Hook	0°	+8°	3.5	620-13H-5	620-23H-5	630-13H-5	630-23H-5
4 Bicuspid with Hook	+7°	0°	3.2	620-14H-5	620-24H-5	630-14h-5	630-24H-5
5 Bicuspid with Hook	+7°	0°	3.2	620-14H-5	620-24H-5	630-14H-5	630-24H-5

Mandibular

Tooth	Torque	Angle	M-D	.018"		.022"	
				R	L	R	L
1 Central	+6°	0°	3.15	620-31-5	620-31-5	630-31-5	630-31-5
2 Lateral	+6°	0°	3.15	620-31-5	620-31-5	630-31-5	630-31-5
3 Cuspid with Hook	0°	+3°	3.5	620-43H-5	620-33h-5	690-43H-5	690-33H-5
4 Bicuspid with Hook	+12°	0°	3.2	620-44h-5	620-34H-5	630-44H-5	630-34h-5
5 Bicuspid with Hook	-17°	0°	3.2			690-45H-5	690-35H-5

Single patient kit

Patient Kit	Cuspid Bicuspid hook		Cuspid hook	
	.018"	.022"	.018"	.022"
Upper Lower 5*5	620-553	690-553		
Upper 5*5	620-503	630-503		
Lower 5*5	620-053	690-053		
Upper Lower 3*3			620-331	690-331
Upper 3*3			620-301	630-301
Lower 3*3			620-031	690-031

Brackets identification

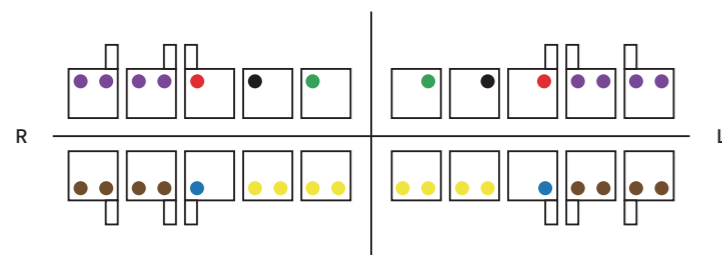

✳ Standard(Edgewise) Prescription

Maxillary

Tooth	Torque	Angle	M-D	.018"		.022"	
				R	L	R	L
1 Central	0°	0°	3.20	640-11-5	640-21-5	650-11-5	650-21-5
2 Lateral	0°	0°	3.15	640-12-5	640-22-5	650-12-5	650-22-5
3 Cuspid with Hook	0°	0°	3.20	640-13H-5	640-23H-5	650-13H-5	650-23H-5
4 Bicuspid with Hook	0°	0°	3.20	640-13H-5	640-23H-5	650-13H-5	650-23H-5
5 Bicuspid with Hook	0°	0°	3.20	640-13H-5	640-23H-5	650-13H-5	650-23H-5

Mandibular

Tooth	Torque	Angle	M-D	.018"		.022"	
				R	L	R	L
1 Central	0°	0°	3.15	640-31-5	640-31-5	650-31-5	650-31-5
2 Lateral	0°	0°	3.20	640-31-5	640-31-5	650-31-5	650-31-5
3 Cuspid with Hook	0°	0°	3.20	640-23H-5	640-13H-5	650-23H-5	650-13H-5
4 Bicuspid with Hook	0°	0°	3.20	640-23H-5	640-13H-5	650-23H-5	650-13H-5
5 Bicuspid with Hook	0°	0°	3.20	640-23H-5	640-13H-5	650-23H-5	650-13H-5

Single patient kit

Patient Kit	Cuspid Bicuspid hook		Cuspid hook	
	.018"	.022"	.018"	.022"
Upper Lower 5*5	640-553	650-553		
Upper 5*5	640-503	650-503		
Lower 5*5	640-053	650-053		
Upper Lower 3*3			640-331	650-331
Upper 3*3			640-301	650-301
Lower 3*3			640-031	650-031

Brackets identification

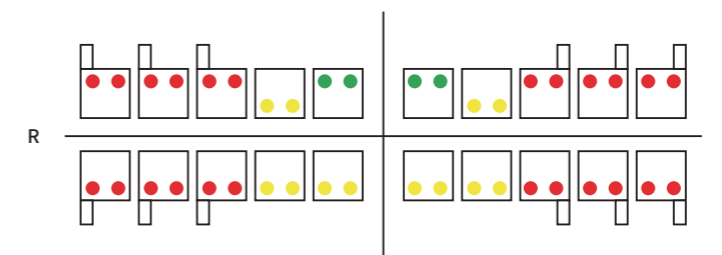

Metal tie-wing brackets

# BB2 CLM



Achieve Consistently Accurate Placement The BB2-CLM Bracket's rhomboid shape is specifically designed to position the bracket easily and accurately. The bracket's vertical components give fast, accurate alignment with the long axis of the clinical crown, while the horizontal elements are aligned and parallel to the incisal edge of the tooth. All brackets are manufactured with Cobalt-Chromium Alloy Material to address your nickel-sensitive patients.

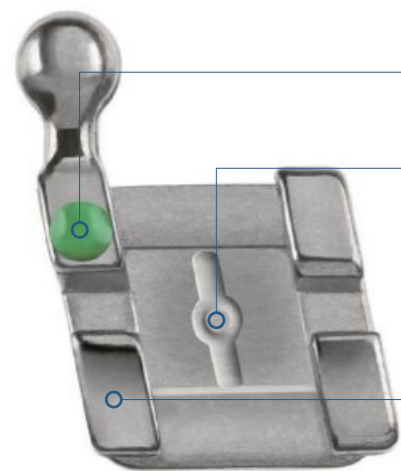

- **Color-Coded ID System** Each bracket is individually color-coded for easy identification.
- **Accurate Placement** Mesial distal tie wings and a permanent vertical scribe line are parallel to the long axis of the clinical crown - The vertical and placement lines facilitate a more accurate Placement of each bracket on the long axis for bonding.
- **Ease of Use** The parallel tie wing design allows tweezers, or bracket holders, to securely hold the bracket in place during bonding.
- **True Straight Archwire System** to give you ultimate precision and control, torque is incorporated into each bracket base.

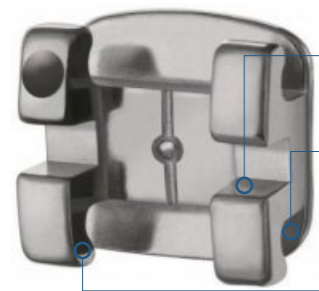

- **Easy Archwire Changes.** Beveled edges of the archwire slot provide easy placement and removal of the archwire.
- **Low Profile for Patient Comfort.** Brackets are radiused and polished for maximum patient comfort.
- **Easy Ligation** Ample area under each tie wing allows easy ligation.



SEM of BB2-M Micro-Etched Base



### Rhomboid Shape Design

- Mesial and distal tie wings are parallel to the long axis of the clinical crown.
- Vertical scribe line aligns with the long axis of the clinical crown.
- Archwire slot and base are parallel to incisal edge of tooth.

- **Exceptional Clinical Results and Case Finishing:** The accurate placement of the bracket can translate into a more exact finish and consistent result. You will truly appreciate the beautiful case finishing that may be achieved with the BB2-M Bracket!
- **Patient Comfort and Aesthetics:** The BB2-M Bracket is designed with your patient in mind. Its small shape, reduced bracket height and smooth, radiused tie wings offer your patient an aesthetic look and comfortable feel.
- **Perfect Fit:** Each BB2-M Bracket Base is contoured in both the mesial-distal, and gingival-occlusal directions for a more "glove type" fit to the tooth surface. The compound, ontoured bracket base reduces bracket rock and adds to the bond strength.

## \* ROTH Prescription

### Maxillary

Tooth	Torque	Angle	.018"		.022"	
			R	L	R	L
1 Central	+12°	+5°	101-11-5	101-21-5	111-11-5	111-21-5
2 Lateral	+8°	+9°	101-12-5	101-22-5	111-12-5	111-22-5
3 Cuspid with Hook	-2°	+11°	101-13H-5	101-23H-5	111-13H-5	111-23H-5
4 Bicuspid with Hook	-7°	0°	101-14H-5	101-24H-5	111-14H-5	111-24H-5
5 Bicuspid with Hook	-7°	0°	101-14H-5	101-24H-5	111-14H-5	111-24H-5

### Mandibular

Tooth	Torque	Angle	.018"		.022"	
			R	L	R	L
1 Central	0°	0°	101-31-5	101-31-5	111-31-5	111-31-5
2 Lateral	0°	0°	101-31-5	101-31-5	111-31-5	111-31-5
3 Cuspid with Hook	-11°	+5°	101-43H-5	101-33H-5	111-43H-5	111-33H-5
4 Bicuspid with Hook	-17°	0°	101-44H-5	101-34H-5	111-44H-5	111-34H-5
5 Bicuspid with Hook	-22°	0°	101-45H-5	101-35H-5	111-45H-5	111-35H-5

### Single patient kit

Patient Kit	Cuspid Bicuspid hook	
	.018"	.022"
Upper Lower 5*5	101-553H	111-553H

### Brackets identification

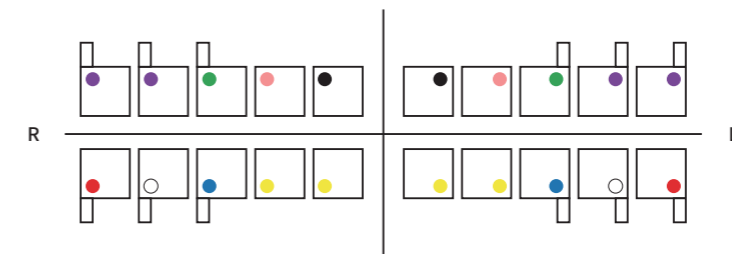

- **Biocompatible Material:** The bracket is biocompatible manufactured from cobalt-chromium alloy, which is a Nickel-Lite material reducing the risk of allergic reactions for your nickel-sensitive patients.
- **Can be Ordered Based on Doctor's Prescription Preference:** Available in Roth and McLaughlin, Bennett and Trevisi Prescriptions, in .018 and .022 slots. The bracket may also be ordered with optional rounded and smooth hooks on 3, 4 & 5's. In addition, the BB2-M Bracket works well with all the new high technology wires and arch forms, making them very adaptable for each doctors' personal preference.
- **Optimal Mechanical Characteristics:** The MIM process (Metal Injection Molding), together with the one-piece design, increases the strength, accuracy and durability of the BB2-M Bracket. It features micro-etched Base, to increase greater bond strength and reduce bond failure.

\* MBT Prescription

Maxillary

Tooth	Torque	Angle	.022"	
			R	L
1 Central	+17°	+4°	121-11-5	121-21-5
2 Lateral	+10°	+8°	121-12-5	121-22-5
3 Cuspid with Hook	-7°	+8°	121-13H-5	121-23H-5
4 Bicuspid with Hook	-7°	0°	121-14H-5	121-24H-5
5 Bicuspid with Hook	-7°	0°	121-14H-5	121-24H-5

Mandibular

Tooth	Torque	Angle	.022"	
			R	L
1 Central	-6°	0°	121-31-5	121-31-5
2 Lateral	-6°	0°	121-31-5	121-31-5
3 Cuspid with Hook	-6°	+3°	121-43H-5	121-33H-5
4 Bicuspid with Hook	-12°	0°	121-44H-5	121-34h-5
5 Bicuspid with Hook	-17°	0°	121-45H-5	121-35H-5

Single patient kit

Patient Kit	Cuspid Bicuspid hook
	.022"
Upper Lower 5*5	121-553H

Brackets identification

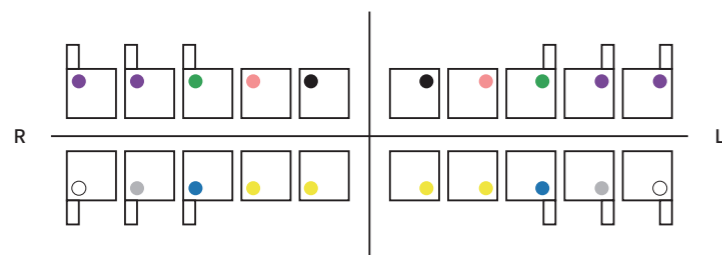

Chois Lingual Brackets

CLB



Chois Lingual Bracket system is designed for a two-point improvement during lingual treatment. First, the anterior piece is positioned at the correct angle and torque that doctors intend by dual wires in dual-slot design. Second, the bracket's in/out offset is applied to make a Straight Wire Appliance. O-ring ligation and less bend SWA design reduce treatment time.



\* Brackets for anterior

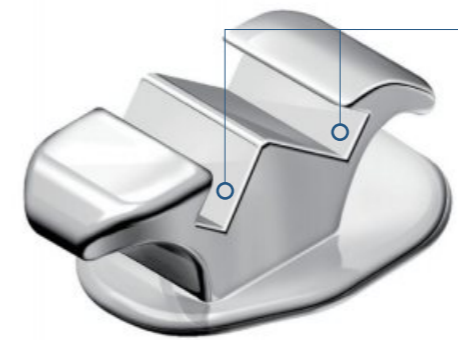

■ Dual wires hold tooth at a more precise position as doctor's intended.



• Every bracket has an 80-mesh design for strong bonding strength until the end of treatment.

\* Brackets for Posterior



• In/out offset applied bracket body to make SWA and raise conveniently during treatment.

\* Brackets for molars



• Special designed tie wing and bracket size act as an anchorage during treatment.



Tube type appliance

# MTA



Simple, Esthetic and Rapid Alignment using Mini-Tube Appliance

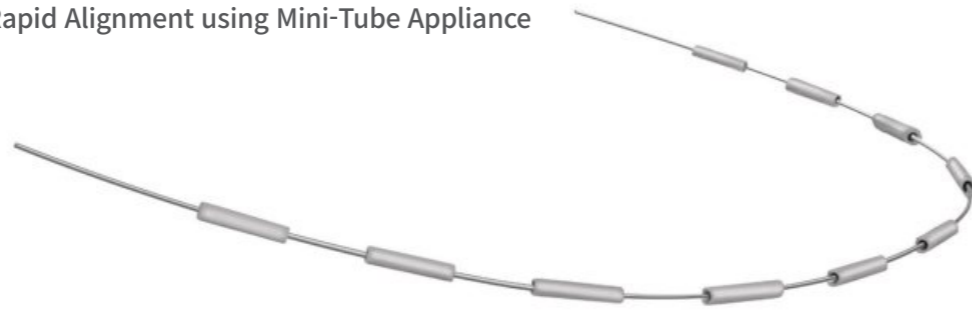

## \* Mini-Tube



MTA



Round Type [650-01]



Semi-Round Type [650-02]



One-side flattened Type [650-53]



Silver MTA



Silver Tube, 3mm [650-06]



Silver Tube, 2mm [650-07]

## \* MTA wire



012 NiTi [750-01]



014 NiTi [750-02]

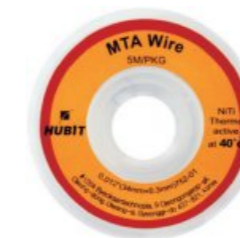

40°C Thermo-active 012 NiTi [752-01]



45°C Thermo-active 012 NiTi [753-01]

## \* Step bend plier

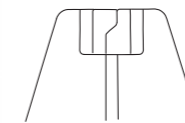

Left [650-04]

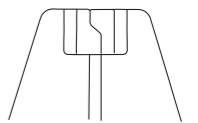

Right [650-05]

## \* Forced positioner

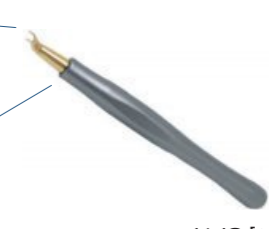
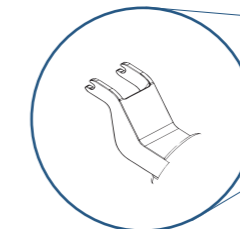

Labial용 [650-51]

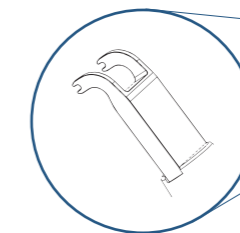

Lingual용 [650-52]

※ MTA Professional kit

MTA Professional kit component

Mini-tube	round tube	5pkg
	semi-round tube	5pkg
	silver tube, 3mm	5pkg
	silver tube, 2mm	5pkg
	one-side flattend tube	5pkg
MTA wire	012 NiTi	1roll
	014 NiTi	1roll
	40°C Thermo-active 012	NiTi 1roll
	45°C Thermo-active 012	NiTi 1roll
Step bend plier	Left & Right	2ea
Forced positioner	Labial & Lingual	2ea
Strip holder		2ea
Perforated strip		5ea
Strip		20ea



※ Treatment cases by use of MTA

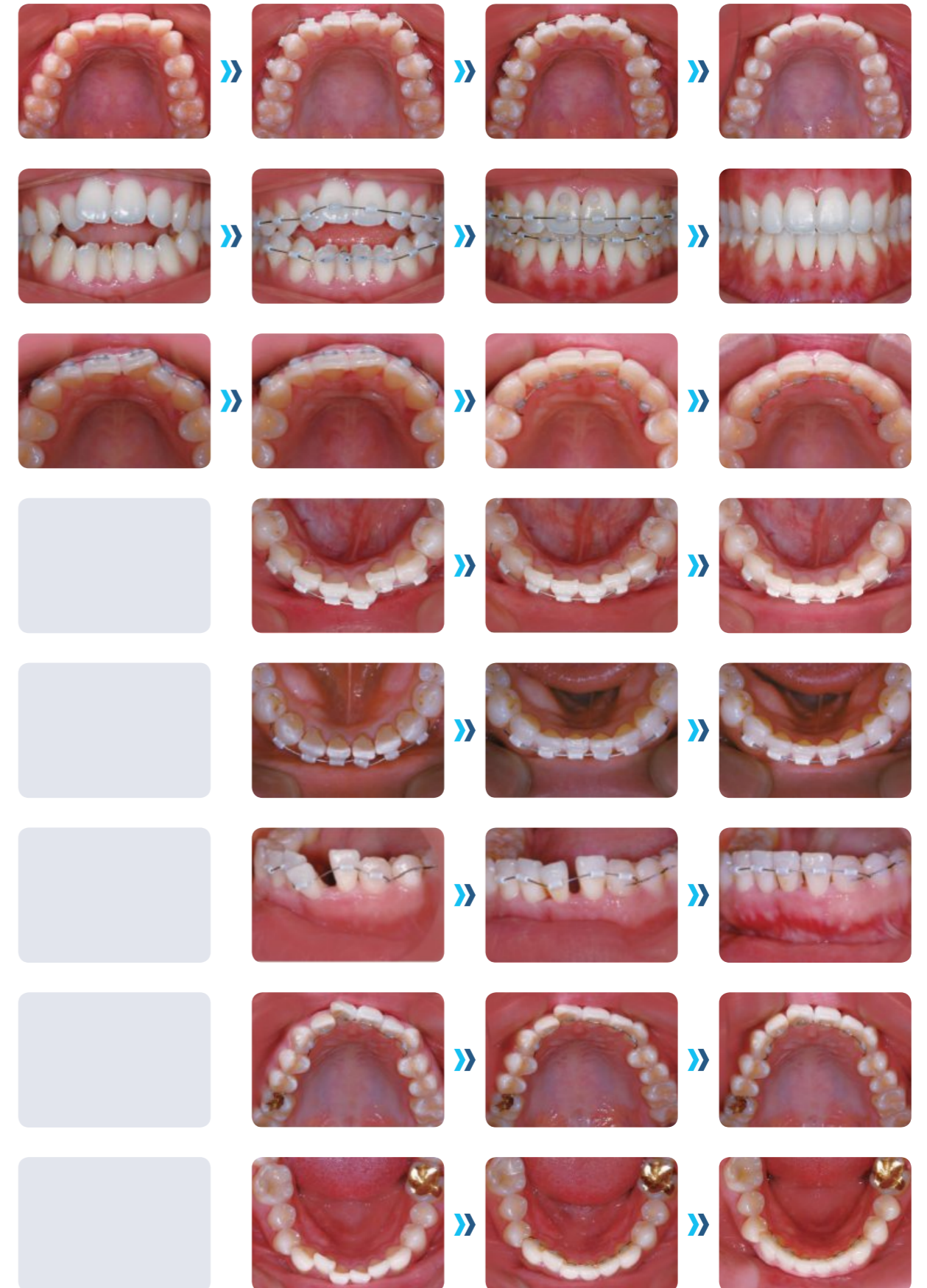



## Archwires



# OSSTEM ORTHODONTICS SOLUTION

PRODUCT CATALOGUE

\* Archwires

BB4 NiTi Archwire  
BB2 Archwire

50  
51

# BB4 NiTi Archwire



### Tinius Olsen Load Chart

- NiTi Archwire .016" Superelastic (AUSTENITIC)
- Based on .250 in. 1b. Load and 1/4" span (@100°F)

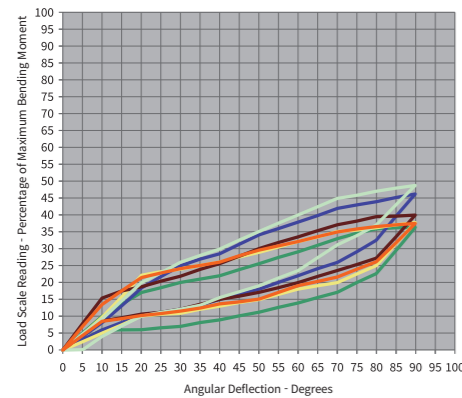

### \* Quality NiTi wire use

- Choose a USA supplier for super-elastic performance.

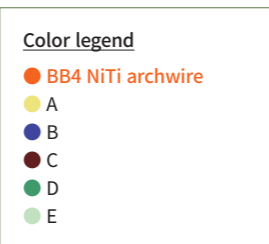

### \* Ceramic coating know how

- Best matched with aesthetic brackets.
- OSSTEM ORTHODONTICS has distributed durable ceramic-coated wires since 2010.
- Does business with a global brand in the USA, as for OEM.
- According to lab test results, the coating surface can sustain for up to 4 weeks.



Round wire	Upper	Lower
.012"	701-11-10	701-21-10
.014"	702-11-10	702-21-10
.016"	703-11-10	703-21-10
.018"	704-11-10	704-21-10
.020"	705-11-10	705-21-10

Rectangular	Upper	Lower
016*016	706-11-10	706-21-10
016*022	707-11-10	707-21-10
017*025	709-11-10	709-21-10
018*025	710-11-10	710-21-10
019*025	711-11-10	711-21-10
021*025	712-11-10	712-21-10

# BB2 Archwire



### Tinius Olsen Load Chart

- NiTi Archwire .016" Superelastic (AUSTENITIC)
- Based on .250 in. 1b. Load and 1/4" span (@100°F)

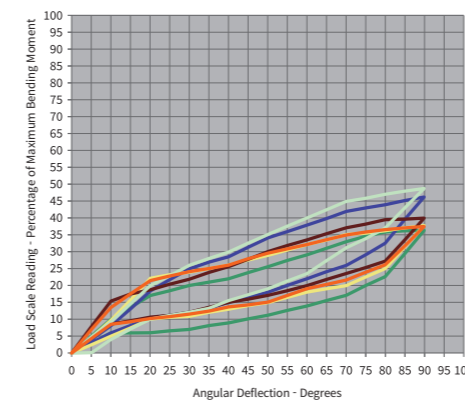

### \* Quality NiTi & SS wire use

- Choose a USA supplier for super-elastic performance.
- Precise wire surface finishing for lower friction and accurate wire dimensions

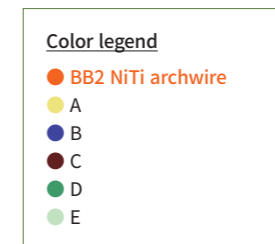

### NiTi Archwire

Round wire	Upper	Lower
.012"	771-11-10	771-21-10
.014"	772-11-10	772-21-10
.016"	778-11-10	778-21-10
.018"	774-11-10	774-21-10
.020"	775-11-10	775-21-10

Rectangular	Upper	Lower
016*016	776-11-10	776-21-10
016*022	777-11-10	777-21-10
017*025	779-11-10	779-21-10
018*025	780-11-10	780-21-10
019*025	781-11-10	781-21-10

### SS Archwire

Round wire	Upper	Lower
.012"	771-10-25	771-20-25
.014"	772-10-25	772-20-25
.016"	778-10-25	778-20-25
.018"	774-10-25	774-20-25
.020"	775-10-25	775-20-25

Rectangular	Upper	Lower
016*016	776-10-25	776-20-25
016*022	777-10-25	777-20-25
017*025	779-10-25	779-20-25
018*025	780-10-25	780-20-25
019*025	781-10-25	781-20-25
021*025	782-10-25	782-20-25

Mini implants

---



# OSSTEM ORTHODONTICS SOLUTION

PRODUCT CATALOGUE

**\* Mini implants**

OrthAnchor	54
Mini Screw	60
e-Drvier	62

# OrthAnchor



- High fracture resistance (material: Ti. alloy).
- Etch surfaces reduces insertion failure by 20%
- Optimal anchorage force with simple and smooth insertion.

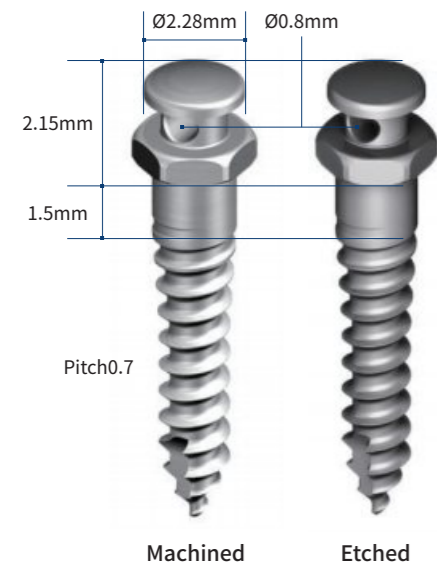

	6mm	8mm	10mm
Ø1.2mm	Ø1.2x6		
Ø1.4mm	Ø1.4x6	Ø1.4x8	
Ø1.6mm	Ø1.6x6	Ø1.6x8	Ø1.6x10
Ø1.8mm	Ø1.8x6	Ø1.8x8	Ø1.8x10

### \* Etched Surface

20% reduced Insertion Failure Rate.

### \* High Fracture Resistance

15~30% improved than Competitor's screw.  
→ Enables Stable Insertion without any fracture.

### \* Smooth Insertion & Stable Anchorage Force

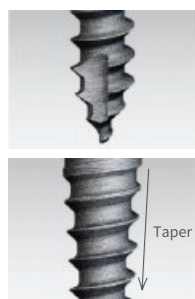

- **Sharpened Tip**  
Enables Smooth & Fast Insertion.
- **Tapered Design**  
Stable Anchorage from the Initial stage.

Comparison of Insertion Failure

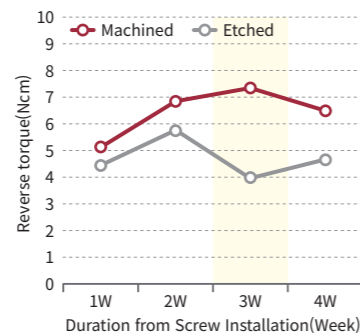

Comparison of Failure Strength

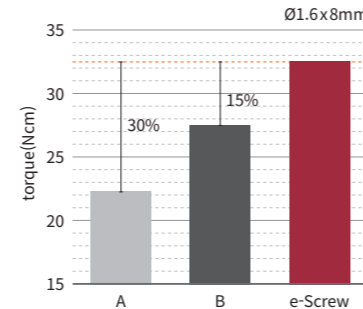

### Applicable position to insertion

Incisor intrusion (Antero-labial Alveolar process)	Ø1.6, 6mm
Molar contraction, protraction, retraction (Mid-palatal suture)	Ø1.8, 6~8 mm
Anterior (full arch) retraction / molar intrusion	Ø1.8~2.0, 10~12mm
Molar protraction (Antero-palatal Alveolar process)	Ø1.6, 6mm
Anterior (Full arch) retraction (IZC)	Ø1.8~2.0, 10~12mm
Anterior (full arch) retraction (Buccal shelf)	Ø1.8~2.0, 10~12mm
Full arch (molar) retraction (Retromolar pad)	Ø1.8, 6~8mm
Full arch (molar) retraction (Ascending ramus)	Ø1.8, 10mm

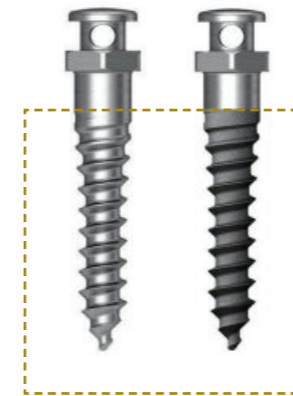

Same design, two options for surface treatment.



	Through hole	Bracket head	Small head	Simple head
Sterilized	0	0	0	0
Machined surface	0	0	0	0
Etched surface	0			0

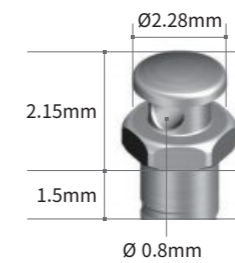

### \* Through hole

- The hole can be ligated with wires (.022").
- Head designed for easy ligate with wire, chain or springs.



### \* Simple head

- Less irritation than through hole.
- Ø 2.5 of coil spring can be use for ligation.

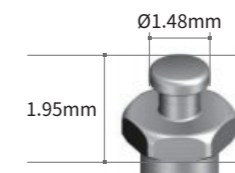

### \* Small head

- Less irritation than simple head.
- Ø 1.5 and 2.0 of coil spring can be use for ligation.

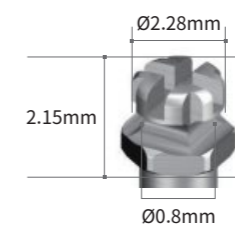

### \* Bracket head

- Head can be used to ligate other materials.

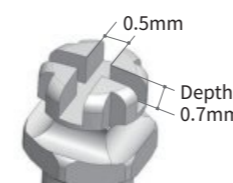

✳ Through hole

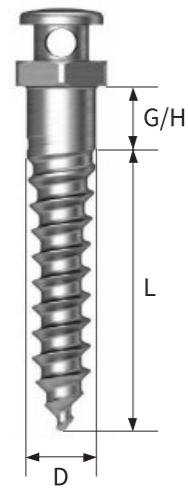

D \ L	6	8	10	
Ø1.2				
	G/H 1.5	OSTH1206	OSTH1208	
Ø1.4				
	G/H 1.5	OSTH1406	OSTH1408	
Ø1.6				
	G/H 1.5	OSTH1606	OSTH1608	OSTH1610
	G/H 4.0	OSTH16064		
Ø1.8				
	G/H 1.5	OSTH1806	OSTH1808	OSTH1810
	G/H 4.0	OSTH18064		

✳ Simple head

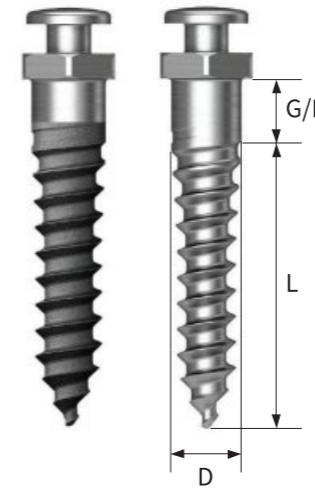

D \ L	6	8	10	
Ø1.2				
	G/H 1.5	OSSH1206	OSSH1208	
Ø1.4				
	G/H 1.5	OSSH1406	OSSH1408	
Ø1.6				
	G/H 1.5	OSSH1606	OSSH1608	OSSH1610
	G/H 4.0	OSSH16064		
Ø1.8				
	G/H 1.5	OSSH1806	OSSH1808	OSSH1810
	G/H 4.0	OSSH18064		

✳ Small head

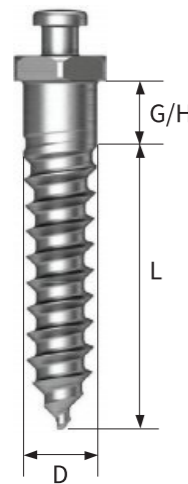

D \ L	6	8	10
Ø1.4			
	G/H 1.5	OSSH1406	OSSH1408
Ø1.6			
	G/H 1.5	OSSH1606	OSSH1608
Ø1.8			
	G/H 1.5	OSSH1806	OSSH1808

✳ Bracket head

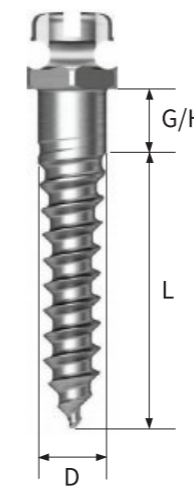

D \ L	6	8	10
Ø1.4			
	G/H 1.5	OSBH1406	OSBH1408
Ø1.6			
	G/H 1.5	OSBH1606	OSBH1608
Ø1.8			
	G/H 1.5	OSBH1806	OSBH1808

**\* Ortho KIT**

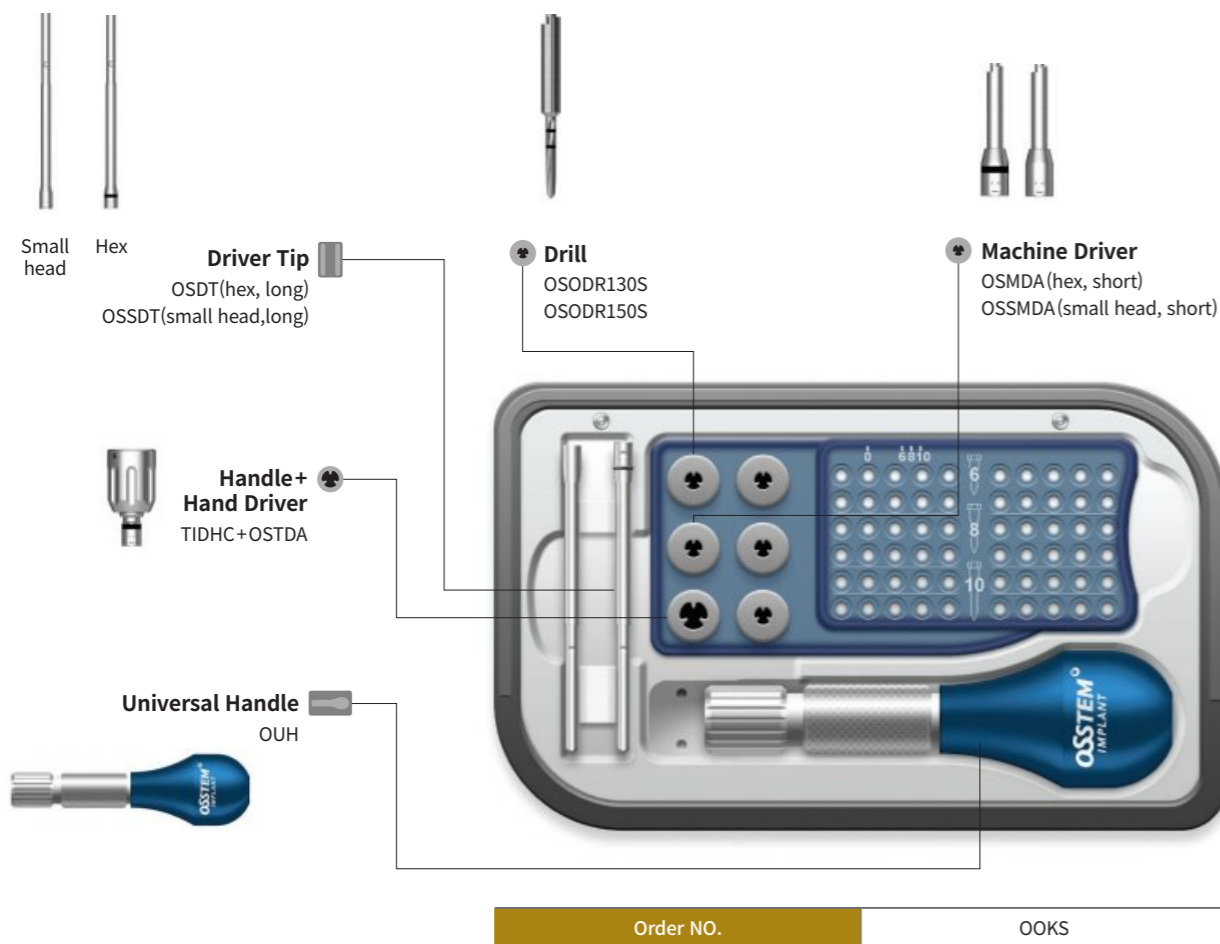

**\* Drill**

- Use drill by connecting with handpiece. (engine)
- $\varnothing 1.0$  drill: use before  $\varnothing 1.2/1.4$  screw insertion.
- $\varnothing 1.3$  drill: use before  $\varnothing 1.6$  screw insertion.
- $\varnothing 1.5$  drill: use before  $\varnothing 1.8$  screw insertion.
- Recommend speed of drill: 800 rpm. (high speed)
- Before screw insertion recommend to the eliminated cortical bone only. (if the cortical bone were very thick, drilling equal length as screws)
- $\varnothing 1.0$  drill is not included in the Kit.

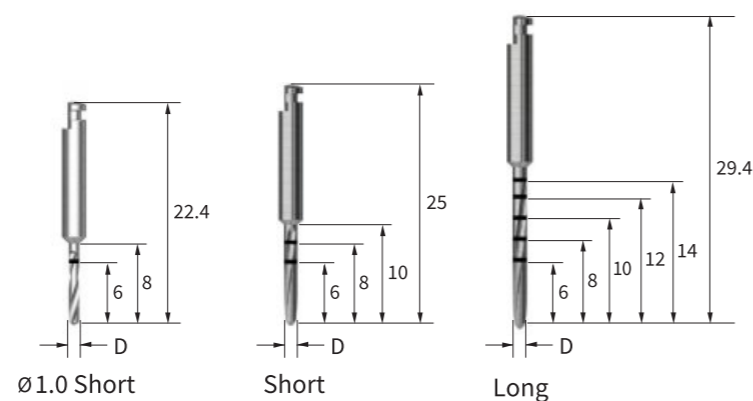

L \ D	$\varnothing 1.0$	$\varnothing 1.3$	$\varnothing 1.5$
Short	OSODR100S	OSODR130S	OSODR150S
Long	-	OSODR130C	OSODR150C

**\* Universal Handle**

- The universal handle can be used by connecting with the driver tip to screw insertion.
- The scribed grip to support manual insertion.

Order NO.	OUH
-----------	-----

**\* Driver Tip**

- Driver tip use to screw insertion by connecting with Universal handle.
- Hex driver designed to connect with normal head screw.
- Small head driver designed to connect with small head screw.

L Type	Hex	Small Head
Short(L)	OSDTS(45)	OSSDTS(45)
Long(L)	OSDT(67)	OSSDT(67)

**\* Driver Handle**

- Driver handle use to screw insertion by connecting with a Hand driver.

Order NO.	TIDHC
-----------	-------

**\* Hand Driver**

- Hand driver designed to screw insertion by connecting with Driver handle or ratchet wrench.
- Two types of Hand driver to use different size of the screw head.
- Hex driver for normal size of the screw head, and small driver for the small size of the screw head.
- Small head hand driver is not included in the Kit.

Hex	Small Head
OSTDA	OSSTDA

**\* Machine Driver**

- Machine driver designed to screw insertion by connecting with engine.
- Two types of hand driver to use different size of the screw head.
- Hex Machine driver for normal size of the screw head.
- Small head Machine driver for the small size of the screw head.

L Type	Hex	Small Head
Short(L)	OSMDA(21.4)	OSSMDA(21.4)
Long(L)	OSMDB(31.4)	OSSMDB(31.4)

# Mini Screw



## \* 3S Screw

- Safe use
- Simple works
- Strong maintenance



**Button head**  
makes it possible  
touse coil spring and  
chains



**Multi hole**  
makes it possible touse  
various wires and pins



**Deep valley**  
spiral makes  
strongermaintenance  
after loading



**Round shape**  
enlarges a contactpart  
with the soft tissue



**Cutting**  
end for Self-drilling



**Taperd type screw**  
offers betteradaptability  
to the bone

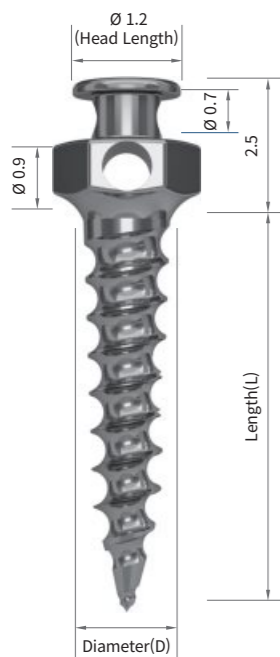

### Standard Type

Size	Order NO.
D Ø1.2 X 6mm	OA1206
D Ø1.2 X 8mm	OA1208
D Ø1.4 X 6mm	OA1506
D Ø1.4 X 8mm	OA1508
D Ø1.4 X 10mm	OA1510
D Ø1.6 X 6mm	OA1606
D Ø1.6 X 8mm	OA1608
D Ø1.6 X 10mm	OA1610
D Ø1.8 X 8mm	OA1808
D Ø1.8 X 10mm	OA1810
D Ø2.0 X 8mm	OA2008
D Ø2.0 X 10mm	OA2010

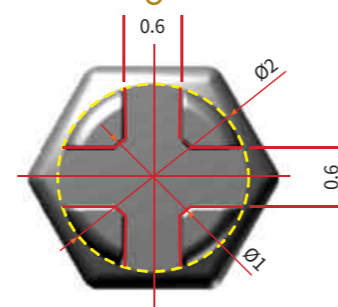

### Cross head Type

Size	Order NO.
Cross Head Screw D Ø1.4 X 8mm	OC1408
Cross Head Screw D Ø1.6 X 8mm	OC1608

## \* MINI SCREW TOOL



Surgical Tray [801-61]



Handle Driver [801-62]



Small Hand Driver [801-66]



Driver Shaft [801-63]  
(All kinds of Handle Driver can be used)



Long Tip [801-64]



Short Tip [801-65]



Drill Tip [801-67]

### Mini Screw Tool

Type	Order NO.
Mini Screw Tool Kit	800-00
Surgical Tray	801-61
Handle Driver	801-62
Driver Shaft	801-63
Long Tip	801-64
Short Tip	801-65
Small Hand Driver	801-66
Drill Tip	801-67

# e-Driver



- Motor-powered insertion tool.
- Optimized torque options for mini-implant use.
- More speed options.



## \* All prosthesis-related Screw Fastenings in One

- Minimize fracture/Loosening with precise fastening torque
- Easy access to the posterior area by contra-angle design
- Shorten chair time due to Rapid fastening



## \* From Insertion to Removal

- 15~35Nm torque allows insertion and removal, even at a hard bone
- Torque setting function minimizes fracture/detachment of orthodontic screws

### 1) Strong and Precise Torque

- Adjustable within the range of 5Ncm~35Ncm(5Ncm unit)
- Apply torque precisely with auto-stop function
- Check torque change in real-time on the LCD Screen
- Precise calibration by TCS(Torque calibration System)

### 2) Adjustable Speed

- Adjustable between 15RPM-60RPM(15RPM unit)
- The procedure is two times faster than manual operation
- One-touch reverse mode

### 3) German Technology

- Precise torque and speed implementation using high-quality German FAULHABER motor

#### Wireless motor driver

Order NO. 500031

#### Torque Setting Guide

Prosthesis-related Screw	Torque(Ncm)		Orthodontic Screw	Torque(Ncm)	Speed(RPM)
	Mlni	Reg			
Cover Screw, Healing, Imp Coping	5	5	Ø1.4mm	15	25~30
One piece ABT(Rigid, Solid ABT)	30	30			
Two piece ABT(Transfer, Angled ABT)	20	20	Ø1.6mm	25	
Temporary Abutment	20	20			
Cylinder Screw	20	20	Ø1.8mm	30	





## Buccal tubes

---

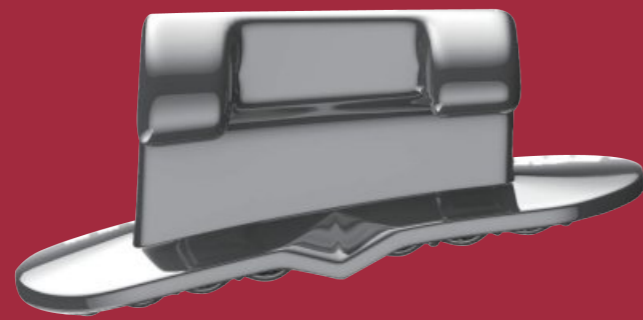

# OSSTEM ORTHODONTICS SOLUTION

PRODUCT CATALOGUE

\* **Buccal tubes**

MAJESTY Tube  
SM Tube

66  
68

# MAJESTY Tube



- Convenient grip and positioning.
- Easy tube recognition.
- Mesh base keeps robust bonding strength.

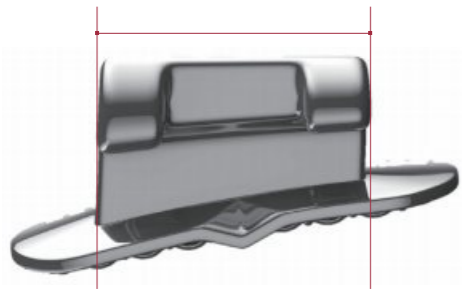

- Parallel designed tube body for easy gripping.
- Vertically bolded body design for orthodontists to hold and position properly.

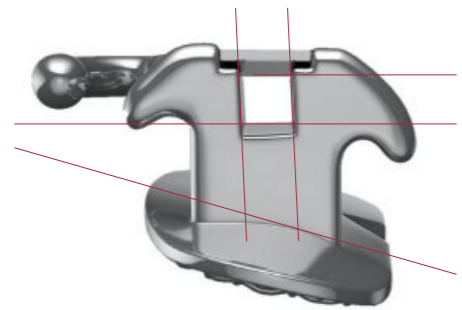

- Precisely engineered to deliver accurate angle and torque value of the slot.
- All manufacturing process are under the control of Osstem Implant Manufacturing Standard.
- Large funneled entrance for guidance of the arch wire.



- Smooth rounded surfaces and patient-friendly mesioingival hooks for comfort.
- The permanent vertical and horizontal scribe lines are parallel to the long axis of clinical crown.
- The scribed lines facilitate more accurate placement of each buccal tube bonding.
- Recognize tubes by identification number on the body surface.



- Options for welding purpose base design.



- 80-gauge mesh bondable pad for consistent and proven bond adhesion.
- Laser-marked FDI code on the base.

## \* Single, Type 1 Prescription

### BONDABLE- Maxillary

Tooth	Torque	Angle	Offset	.018"		.022"	
				R	L	R	L
7 2nd Molar	-14°	0°	14°	560-17-10	560-27-10	570-17-10	570-27-10

### BONDABLE- Mandibular

Tooth	Torque	Angle	Offset	.018"		.022"	
				R	L	R	L
7 2nd Molar	-30°	0°	6°	560-47-10	560-37-10	570-47-10	570-37-10

## \* Single, Type 2 Prescription

### BONDABLE- Maxillary

Tooth	Torque	Angle	Offset	.018"		.022"	
				R	L	R	L
7 2nd Molar	-10°	0°	7°	565-17-10	565-27-10	575-17-10	575-27-10

### BONDABLE- Mandibular

Tooth	Torque	Angle	Offset	.018"		.022"	
				R	L	R	L
7 2nd Molar	-25°	0°	4°	565-47-10	565-37-10	575-47-10	575-37-10

## \* Single, Type 3 Prescription

### BONDABLE- Maxillary

Tooth	Torque	Angle	Offset	.022"	
				R	L
7 2nd Molar	-19°	0°	8°	590-17-10	590-27-10

### BONDABLE- Mandibular

Tooth	Torque	Angle	Offset	.022"	
				R	L
7 2nd Molar	-10°	0°	0°	590-47-10	590-37-10

# SM Tube



- ROTH, MBT and STD Variation-ready.
- Single and twin type #6 tube design is applicable for most clinic uses. Each type has options for convertible caps.
- Every buccal tubes base has bondable and weldable options.



- All #6 tubes feature removable caps. When orthodontists need to use brackets on 1<sup>st</sup> molar the open cap buccal tube can be used



- Twin slot options for auxiliary use.
- Smooth rounded surfaces and patient-friendly messio-gingival hooks for comfort.



- Glove shaped base design fit on molar. Notch- designed base to support tube placing on a correct position.
- Large funneled entrance for guiding the arch wire.



- 80-gauge mesh bondable pad for consistent and proven bond adhesion.
- Laser mark FDI information on the base / SM Tube has weldable base option as well.

## \* Single, ROTH Prescription

### BONDABLE- Maxillary

Tooth	Torque	Angle	Offset	.018"		.022"	
				R	L	R	L
6 1st Molar	10°	0°	7"	500-16-10	500-26-10	510-16-10	510-26-10
7 2nd Molar	14°	0°	7"	500-17-10	500-17-10	510-17-10	510-27-10

### BONDABLE- Mandibular

Tooth	Torque	Angle	Offset	.018"		.022"	
				R	L	R	L
6 1st Molar	20°	0°	4"	500-46-10	500-36-10	510-46-10	510-36-10
7 2nd Molar	25°	0°	6"	500-47-10	500-37-10	510-47-10	510-37-10

### WELDABLE- Maxillary

Tooth	Torque	Angle	Offset	.018"		.022"	
				R	L	R	L
6 1st Molar	10°	0°	7"	501-16-10	501-26-10	511-16-10	511-26-10
7 2nd Molar	14°	0°	7"	501-17-10	501-27-10	511-17-10	511-27-10

### WELDABLE- Mandibular

Tooth	Torque	Angle	Offset	.018"		.022"	
				R	L	R	L
6 1st Molar	20°	0°	4"	501-46-10	501-36-10	511-46-10	511-36-10
7 2nd Molar	25°	0°	6"	501-47-10	501-37-10	511-47-10	511-37-10

## \* Twin, ROTH Prescription

### BONDABLE- Maxillary

Tooth	Torque	Angle	Offset	.018"		.022"	
				R	L	R	L
6 1st Molar	10°	0°	7"	502-16-10	502-26-10	512-16-10	512-26-10

### BONDABLE- Mandibular

Tooth	Torque	Angle	Offset	.018"		.022"	
				R	L	R	L
6 1st Molar	20°	0°	4"	502-46-10	502-36-10	512-46-10	512-36-10

### WELDABLE- Maxillary

Tooth	Torque	Angle	Offset	.018"		.022"	
				R	L	R	L
6 1st Molar	10°	0°	7"	503-16-10	503-26-10	513-16-10	513-26-10

### WELDABLE- Mandibular

Tooth	Torque	Angle	Offset	.018"		.022"	
				R	L	R	L
6 1st Molar	20°	0°	4"	503-46-10	503-36-10	513-46-10	513-36-10

## \* Single, MBT Prescription

## BONDABLE- Maxillary

	Tooth	Torque	Angle	Offset	.022"	
					R	L
6	1st Molar	14°	0°	10°	530-16-10	530-26-10
7	2nd Molar	14°	0°	10°	530-17-10	530-27-10

## BONDABLE- Mandibular

	Tooth	Torque	Angle	Offset	.022"	
					R	L
6	1st Molar	20°	0°	0°	530-46-10	530-36-10
7	2nd Molar	10°	0°	0°	530-47-10	530-37-10

## WELDABLE- Maxillary

	Tooth	Torque	Angle	Offset	.022"	
					R	L
6	1st Molar	14°	0°	10°	531-16-10	531-26-10
7	2nd Molar	14°	0°	10°	531-17-10	531-27-10

## WELDABLE- Mandibular

	Tooth	Torque	Angle	Offset	.022"	
					R	L
6	1st Molar	20°	0°	0°	531-46-10	531-36-10
7	2nd Molar	10°	0°	0°	531-47-10	531-37-10

## \* Twin, MBT Prescription

## BONDABLE- Maxillary

	Tooth	Torque	Angle	Offset	.022"	
					R	L
6	1st Molar	14°	0°	10°	532-16-10	532-26-10

## BONDABLE- Mandibular

	Tooth	Torque	Angle	Offset	.022"	
					R	L
6	1st Molar	20°	0°	0°	532-46-10	532-36-10

## WELDABLE- Maxillary

	Tooth	Torque	Angle	Offset	.022"	
					R	L
6	1st Molar	14°	0°	10°	533-16-10	533-26-10

## WELDABLE- Mandibular

	Tooth	Torque	Angle	Offset	.022"	
					R	L
6	1st Molar	20°	0°	0°	533-46-10	533-36-10

## \* Single, Standard Prescription

## BONDABLE- Maxillary

	Tooth	Torque	Angle	Offset	.018"		.022"	
					R	L	R	L
6	1st Molar	0°	0°	0°	540-16-10	540-26-10	550-16-10	550-26-10
7	2nd Molar	0°	0°	0°	540-16-10	540-26-10	550-16-10	550-26-10

## BONDABLE- Mandibular

	Tooth	Torque	Angle	Offset	.018"		.022"	
					R	L	R	L
6	1st Molar	0°	0°	0°	540-26-10	540-16-10	550-26-10	550-16-10
7	2nd Molar	0°	0°	0°	540-26-10	540-16-10	550-26-10	550-16-10

## Accessories

---

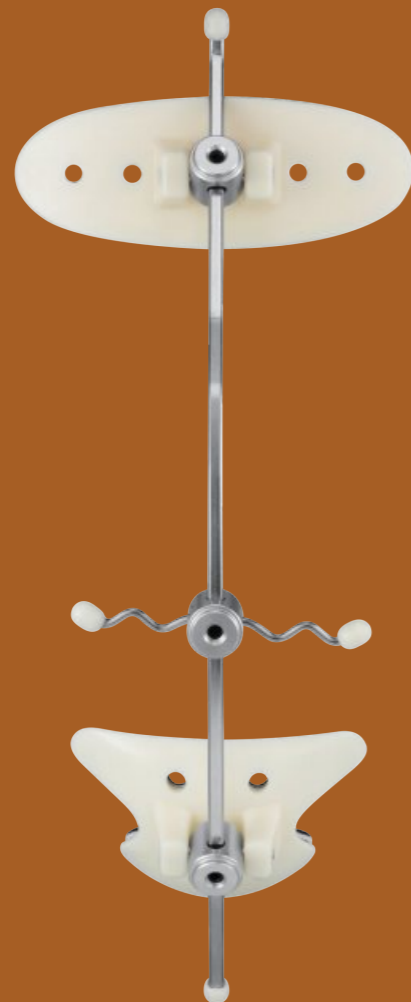

# OSSTEM ORTHODONTICS SOLUTION

## PRODUCT CATALOGUE

* Accessories	Extraoral appliance	BK Mask	74
		Face Mask	75
	Intraoral appliance	Orchestra Pack	76
	Elastomerics	BB2 O-ring	77
		BB2 Chain	
		Elastic Thread	78
		CLB O-ring CLB Power chain	
	Interproximal reducer	Perforated strip	79
		Reducer strip	
	Accessories	KS Lock	80
		Crimpable Hook	
		Lingual Sheath	
		Rolled Ligature Wire	
		Anaper Wax	81
		Dentiform Resin Attachment Brackets bulk case	

# BK Mask



- 50% reduced weight: redesigned appliance, 6 bolts and screws were removed.
- Easy to control pad position and horizontal ligate bar.
- Each position can be controlled by a single screw.
- Selected light weight material with a vertical frame for patient comfort.
- Ivory color pads for an aesthetically-pleasing look.

○ Tangled ligation bar designed for easy ligation and holding in position.

○ Butterfly 3D shaped chin pad for comfortable fitting. (Patent No.: 10-1864311)

● Cotton pad for less chafe and extended use comfort.

● 59mm taller than the prior face mask to improve retraction force.

● Chin cup angle control to fit most patients' face shape.

Type	Order NO.
Ivory 1	801-76



# Face Mask



- Forehead and chin cup pad fixed by two bolts to hold in position.
- Stainless steel frames sustain retraction force.
- Select felt to use on forehead and chin-cup pad for patient comfort.



○ Air holes to ventilate moisture and heat.

○ Heat-treated screws are more durable and hold position solidly.

○ 3D curved designed chin cup tilts to fit on patient's body  
 ■ Cup has a tilting torque for the curved chin line of patient

Type	Order NO.
Skyblue	801-71
Violet	801-72

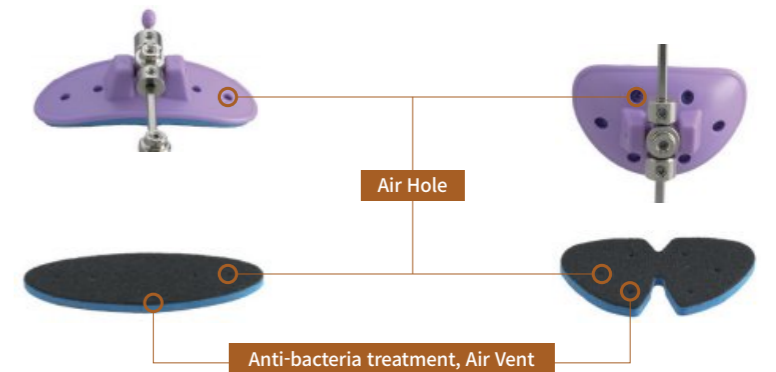

# Orchestra Pack



- Raw material from the USA.
- High-quality elastic performance.
- Long-lasting elastic tension.
- Packaging : 2,000ea/box (100ea/pack, 20packs/box)



**LIGHT**  
3.5 oz / 99 gms  
1/8" / 3.2 mm  
REF HE108-35

**HORN**

**MEDIUM**  
4.5 oz / 128 gms  
1/8" / 3.2 mm  
REF HE108-45

**XYLOPHONE**

**HEAVY**  
6.5 oz / 184 gms  
1/8" / 3.2 mm  
REF HE108-65

**TRIANGLE**

**LIGHT**  
3.5 oz / 99 gms  
3/16" / 4.8 mm  
REF HE316-35

**GUITAR**

**MEDIUM**  
4.5 oz / 128 gms  
3/16" / 4.8 mm  
REF HE316-45

**PIANO**

**HEAVY**  
6.5 oz / 184 gms  
3/16" / 4.8 mm  
REF HE316-65

**TRUMPET**

**LIGHT**  
3.5 oz / 99 gms  
1/4" / 6.4 mm  
REF HE104-35

**HARMONICA**

**MEDIUM**  
4.5 oz / 128 gms  
1/4" / 6.4 mm  
REF HE104-45

**VIOLIN**

**HEAVY**  
6.5 oz / 184 gms  
1/4" / 6.4 mm  
REF HE104-65

**ACCORDION**

**LIGHT**  
3.5 oz / 99 gms  
5/16" / 7.9 mm  
REF HE516-35

**TUBA**

**MEDIUM**  
4.5 oz / 128 gms  
5/16" / 7.9 mm  
REF HE516-45

**HARP**

**HEAVY**  
6.5 oz / 184 gms  
5/16" / 7.9 mm  
REF HE516-65

**DRUM**

**LIGHT**  
3.5 oz / 99 gms  
3/8" / 9.5 mm  
REF HE308-35

**CLARINET**

**MEDIUM**  
4.5 oz / 128 gms  
3/8" / 9.5 mm  
REF HE308-45

**TAMBOURINE**

**HEAVY**  
6.5 oz / 184 gms  
3/8" / 9.5 mm  
REF HE308-65

**BASSOON**

# BB2 O-ring



- Raw material from the USA.
- High-quality elastic performance.
- Long-lasting elastic tension.
- Packaging : 1,008modules/box (42sticks/box, 24modules/stick)

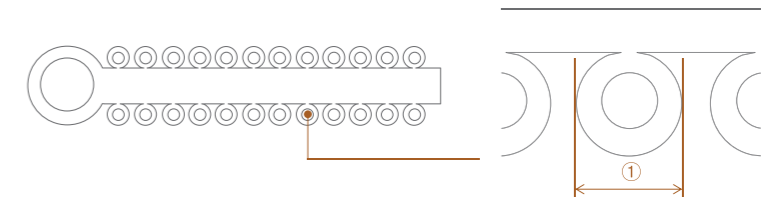

No	MODEL	Order NO.	① diameter	Quantity	Color
1	EOC(Elastic O-Ring Clear)	803-31	3.05	24	Clear
2	EOG(Elastic O-Ring Gray)	803-32	3.05	24	Gray

# BB2 Chain



- Raw material from USA used.
- High-quality elastic performance.
- Long-lasting elastic tension.
- Packaging : 15'(4.6m)/spool

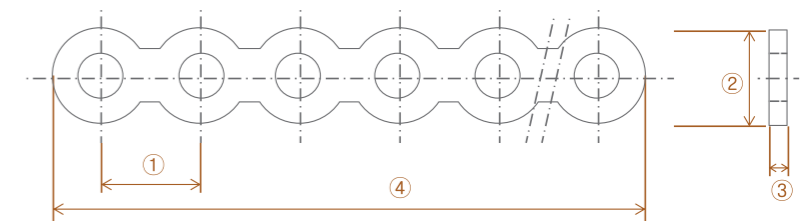

No	MODEL	Order NO.	①	②	③	④	Color
1	ECO(Elastic Chain Open)	803-11	3.1mm	2.8mm	0.63mm		
2	ECW(Elastic Chain Wide)	803-12	4.1mm	2.8mm	0.63mm	4,572mm	Clear
3	ECC(Elastic Chain Closed)	803-13	2.5mm	2.8mm	0.63mm		

- ECO (Elastic Chain Open)
- ECW (Elastic Chain Wide)
- ECC (Elastic Chain Closed)

## Elastic Thread



- Made from strong, high quality elastomeric resins.
- Won't unravel or deteriorate
- Absorbs moisture
- Packaging : 15'(4.6m)/spool

Type	Order NO.	Packing unit
0.45	801-24	5m
0.55	801-25	5m

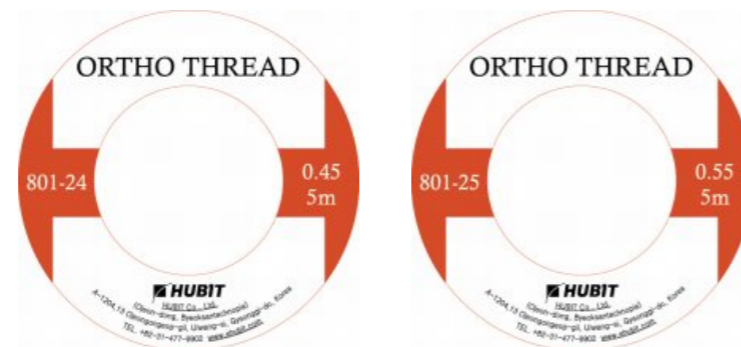

## CLB O-ring



- Designed to fit on CLB lingual brackets, these purple color rings are easily recognized by orthodontists during patient's check up.
- Packaging : 1,008modules/box (42sticks/box, 24modules/stick)

Type	Order NO.
Purple	801-36

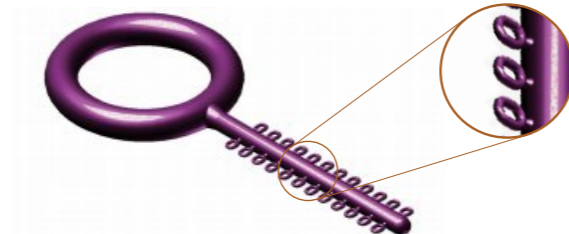

## CLB Power chain



- Designed to fit on CLB lingual brackets
- Packaging : 1,008modules/box (42sticks/box, 24modules/stick)

Type	Order NO.
Clear	801-33



## Perforated strip



- One-side coated by diamond powder. Microscopically thin diamond grit strip surface that grinds teeth smoothly and maintain it's performance after autoclave sterilization.
- Made from German stainless steel
- Length : 150\*4
- Thickness : 0.10mm(grinding part)/0.06mm(center)
- 400 mesh
- Packaging : 5pcs/ case

Type	Order NO.
Perforated Strip (5pcs/pack)	650-08



## Reducer strip



- Reducer Holder
  - Horizontally flat handle support for easy stripping.
  - Quick connect strip blade by hand.
- Reducer strip
  - Diamond grit coated on both sides.
  - Two different sizes (thickness) for easy use.
- Length : 36\*4 mm
- Thickness : 0.16mm(Thin), 0.23mm(Thick)
- Packaging : 10pcs/case, 20pcs/case

Type	Order NO.
Strip Holder (Handle)	801-75
Reducer Strip - Thin (10pcs/pack)	650-16
Reducer Strip - Thin (20pcs/pack)	650-10
Reducer Strip - Thick (10pcs/pack)	650-15
Reducer Strip - Thick (20pcs/pack)	650-09





# KS Lock



- Tiny metal block lock on the archwires and easy to adjust position or removal it
- Suggest position : 1st molar
- Packaging : 10pcs/pack



Type	Order NO.
KS-Lock	801-15
KS-Lock Tool	801-16

# Crimpable Hook



- Metal block clamp arch wire by Crimpable hook pliers use.
- Packaging : 10pcs/pack



Type	Order NO.
Crimpable Hook Base	801-42
Crimpable Hook 2	801-43

# Lingual Sheath



- Packaging : 10pcs/pack



Type	Order NO.
Lingual Sheath	801-10

# Rolled Ligature Wire



- Two size of wire : 0.23', 0.25'
- Packaging : 500g/roll



Type	Order NO.
Roll Ligature Wire 009 (0.23)	501-39
Roll Ligature Wire 010 (0.25)	501-40

# Anaper Wax



- Patient pain relief wax.
- 3 different colors with carrying case.
- Packaging : 100case/box



Type	Order NO.
Anaper Wax (1box=100ea)	801-20
Anaper Wax (1ea)	801-21

# Dentiform

- 3 different tooth root visible study model. (Clear, Blue, Yellow)



Type	Order NO.
Blue	801-81FH
Yellow	801-96FH
Clear	801-92FH

# Resin Attachment



- Packaging : 50pcs/pack



Type	Order NO.
Resin Attachment	680-11

# Brackets bulk case

Type	Order NO.
Bracket Bulk case	801-80



## Instruments

---



# OSSTEM ORTHODONTICS SOLUTION

PRODUCT CATALOGUE

### \* Instruments

MAJESTY Debonding pliers	84
MAJESTY Opener	85
YES Opener	
Step Bend Pliers	86
Wire Pusher	
Forced Positioner	

# Majesty Ceramic Debonding Guide



- OSSTEM ORTHODONTICS delivers a debonding protocol to debond MAJESTY Ceramic brackets without tooth damage and pain.
- We recommend using the Majesty debonding plier for best fit. Please follow debonding guide steps 1 to 3 described below.
- The newly designed instruments are specially calibrated to fit the profile and base of the ceramic brackets, resulting on a fast and comfortable experience.



MAJESTY Debonding pliers

Order NO. SP-248

### Check Point

- Check Majesty Debonding Plier tips before using it.
- The tips should keep in good quality for the best debonding performance.

### STEP 01

Open bracket clips to remove wire. Hold Majesty Debonding Plier gently in a vertical position.



### STEP 02

Grab the bracket corner base with the debonding pliers. The tip of the pliers should be located on the non-hook side corner of the base.

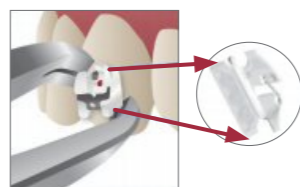

### STEP 03

Detach the bracket from the tooth by turning the debonding pliers to the direction of the tooth root.

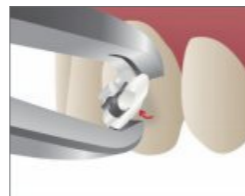

### Bracket Fracture Test

(OSSTEM Lab. Test)

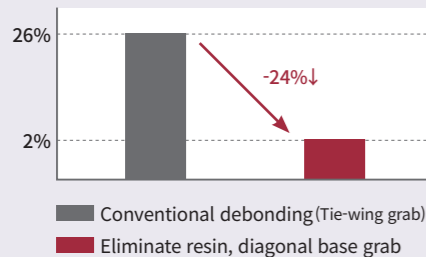

### NOTE

Position the debonding pliers' tip at the corner base rather than to grab the tie-wings of the bracket to reduce bracket fracture and patient pain.

Before you grab the bracket, remove the residual resin at the bracket corner base to significantly reduce bracket fracture.

We do not recommend twisting the debonding pliers mesio-distally. This is to decrease bracket's fracture rate and patient discomfort.

# MAJESTY Opener



■ The Majesty special tool makes opening easy and maintains the clips' long-lasting performance (Patented).

Order NO. 801-601

- The end of the specialized opener (A) is concave to allow easy access and accurate ball clip control (Patented).
- The metal clip was reinforced to 0,14T to strengthen its durability

### Clip Opening. Using A



### Clip Opening. Using B



# YES Opener



### Proper Opening



### Wrong Openings



Order NO. 801-55

## Step Bend Pliers



Type	Order NO.
Left	650-04
Right	650-05

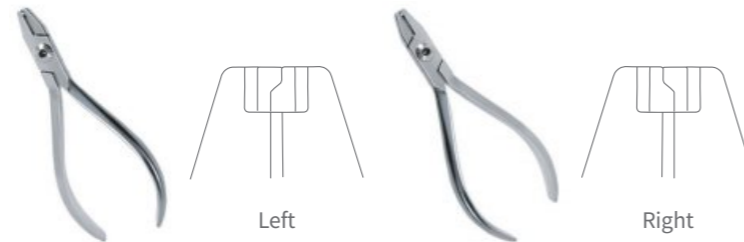

## Wire Pusher



- Using the wire pusher, press the wire and close the cap gently using a finger, as shown in the image above.

### Why wire pusher?

- Using the Wire Pusher minimizes cap breakage and is more convenient for closing the cap.
- Additionally, the Wire Pusher can be used readily for Rect. Wire or thicker wires (0.018 shown above)

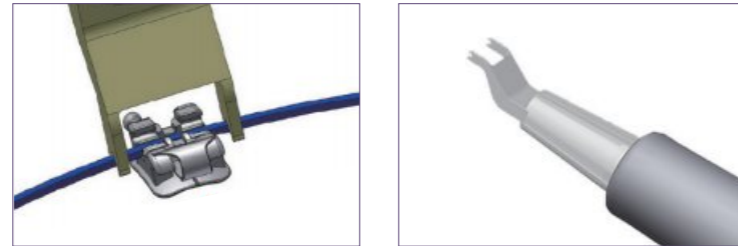

Type	Order NO.
Self Wire Pusher	801-58

## Forced Positioner



Type	Order NO.
Labial	650-51
Lingual	650-52

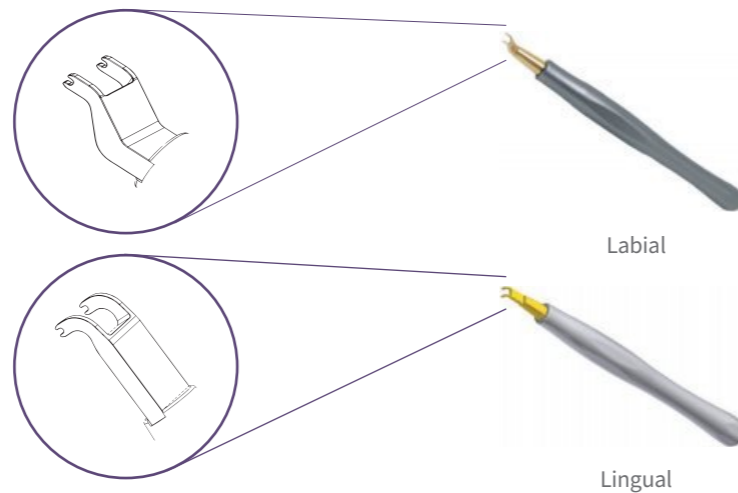

## Social Networking Service

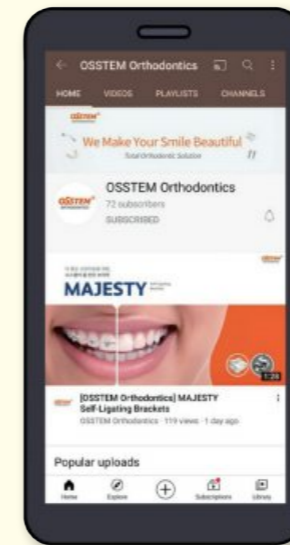

Youtube

<http://b.link/vgbwe>

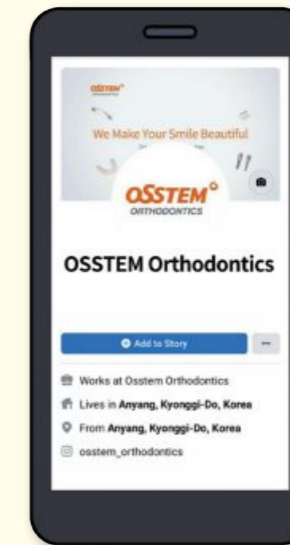

Facebook

<http://b.link/3ufhy>



Instagram

<http://b.link/53v1w>

