

# SUGATSUNE



## PRODUCT HIGHLIGHTS

Manufacturer of the **LAMP**® Brand



# BECAUSE DETAILS MATTER

## THE SUGATSUNE DIFFERENCE

### The LAMP brand

With the LAMP brand, Sugatsune pays particular attention to finding solutions that provide comfort and satisfaction, with special attention to the details that everyone knows really matter.

### Precision and Quality

Our products must always meet your high standards and expectations. The quality and craftsmanship of SUGATSUNE's products guarantee long-term, trouble-free operation.

### Advanced design

SUGATSUNE regularly develops innovative, advanced products and new fitting solutions. Our designers and technicians are always up to date to implement new ideas into exemplary products.

## WHY CHOOSE SUGATSUNE PRODUCTS? BECAUSE DETAILS MATTER.



## Sugatsune is a global manufacturer of high quality, innovative and unique fittings

With its LAMP brand, Sugatsune pays particular care to finding solutions that offer comfort and satisfaction, with a very special attention to details which really matter. Since 1930, Sugatsune has strived to make your living and working environment less stressful and more comfortable by developing unique products.

Ultra-thin magnets, delicately designed hooks, heavy-duty hinges, a large selection of stainless steel items and sliding or swing door systems are just some of the solutions offered by Sugatsune.

Sugatsune is innovative. We love to surprise you with new ideas.

Our Motion Design Tech technology allows you to effectively control your movements. “Soft motion” provides an additional luxurious touch. “Free-stop motion” ensures increased safety. “Power Assist” brings a pleasantly light movement. And with “Unique Motion” Sugatsune offers solutions to open doors invisibly and unexpectedly.

Do you have a difficult task to complete?

With Sugatsune you can solve these!

Do you want a unique and high-quality solution?

Be inspired by our product highlights and find your special touch!

Because details matter...

# PRODUCT CATEGORIES

## HANDLES, PULLS & KNOBS

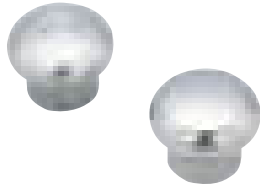

## LOCKS

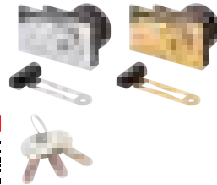

## HOOKS



## HINGES



## BRACKETS AND SHELVING SYSTEMS

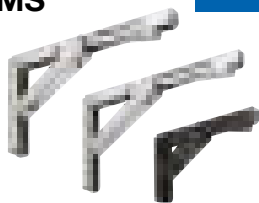

## LID SUPPORTS

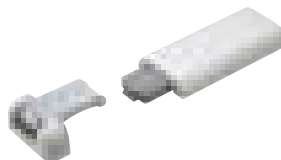

## ARCHITECTURAL DOOR HARDWARE



## CATCHES & LATCHES



## DRAWER SLIDES



## CASTERS AND LEVELING GLIDES

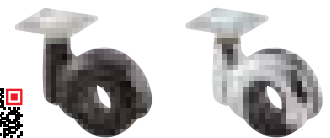

## WARDROBE & CABINET DOOR HARDWARE



## MISCELLANEOUS





## HEAVY DUTY CONCEALED HINGE SERIES

# J95

### Concealed hinge for thick and heavy doors

- 95° opening
- 40 mm cup
- Available in 25 mm, 16 mm overlay and inset
- 3-way-adjustment function by mounting plate (depth + 1.5, - 2.5 mm, vertical +/- 3 mm, overlay [horizontal] + 0, - 4 mm)
- Easy one-touch installation and removal
- Available in nickel and black nickel finish



Product  
Link



# J160

- Wide-angle concealed hinge with soft-close
- 160° opening / Built-in damper
- The built-in damper allows doors to close slowly providing premium door motion
- 3-way adjustability after installation
- Comes with a mounting plate and screw covers
- Available in nickel and black nickel finish



Product  
Link



## EXPLORE THE J95 / 160 SERIES

Max 25 kg and 800 mm wide with 2 hinges, and 40 kg and 900 mm wide with 3 hinges.

Normal Concealed  
Hinges: 5 pcs used

J95: 2 pcs used

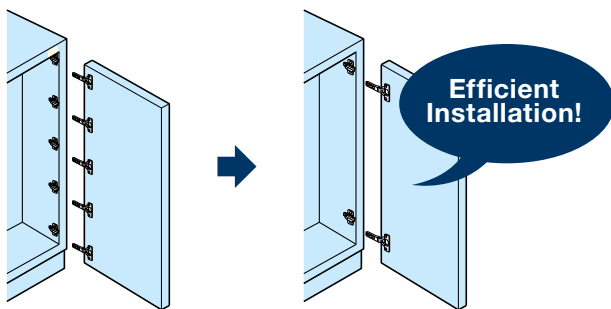

The Number of Necessary Hinges with  
Door Dimensions

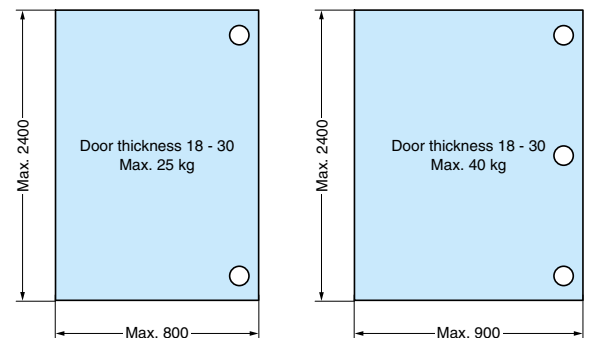

Flat Design

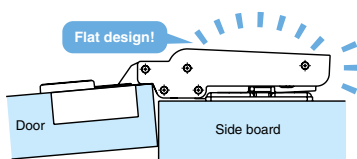

Simple Installation and  
Detachment by One-Touch

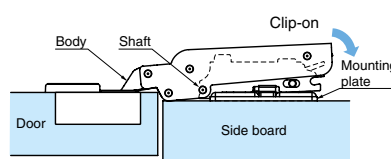

Easy and Fast Adjustment

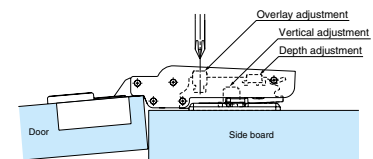

Door can be adjusted by  
turning adjustment screws



## DAMPER HINGE SERIES

# HG-JHM

- Hinge with built-in damper
- The damper unit works to gently close the lid, providing smooth movement in the opening direction
- Different models with several torques available for various door sizes
- For a self-opening function, the HG-JHS model is available
- Ideal for applications ranging from cable management flaps to dressers with mirror



Product  
Link





# EXPLORE THE HG-JH SERIES

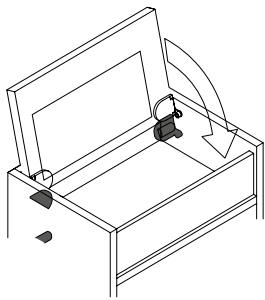

## Soft-Close Motion: Damper Hinge HG-JHM Series

Torque Moment N-m/set

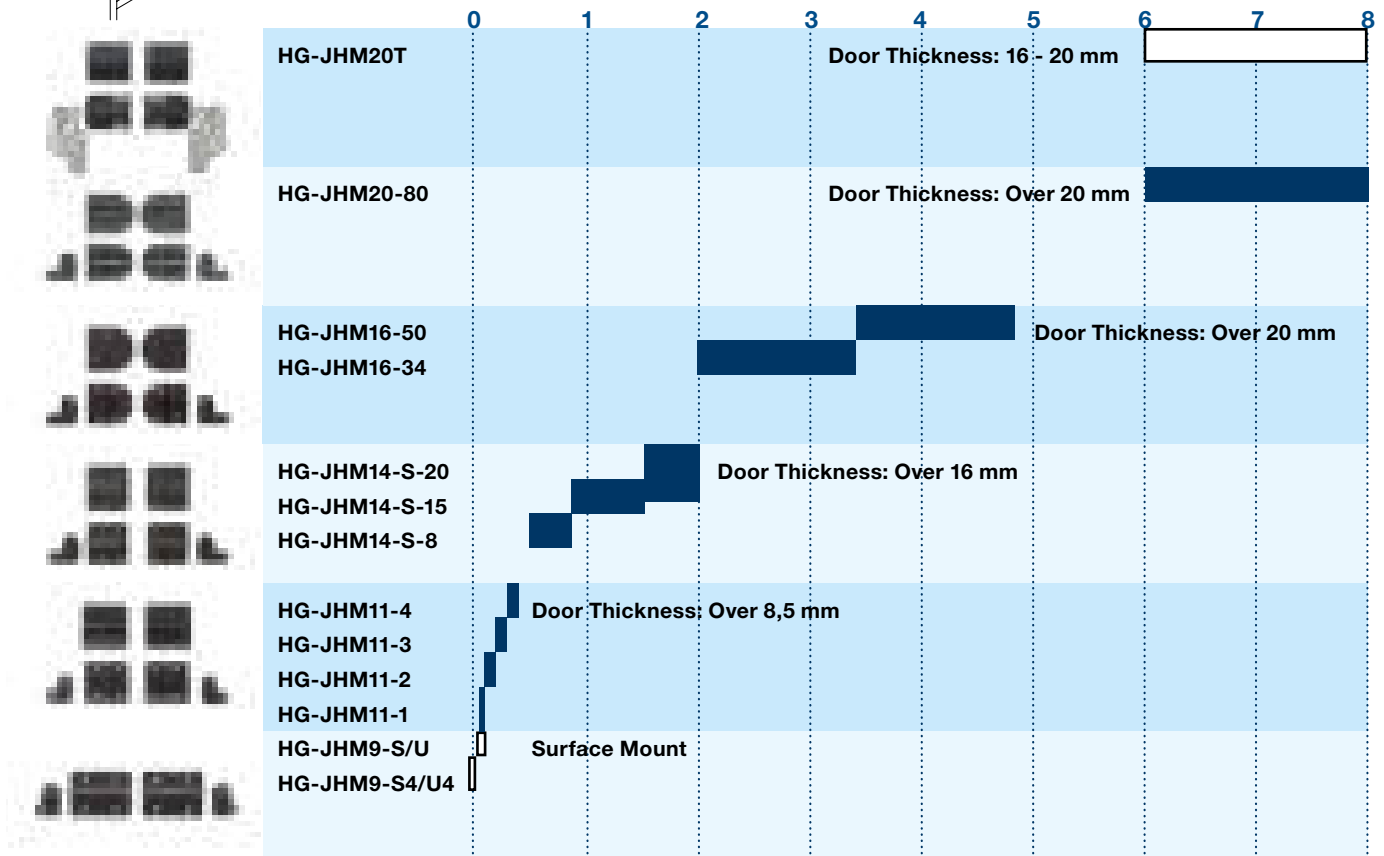

## Push-to-Open Motion: Self Open Mini Damper Hinge HG-JHS Series

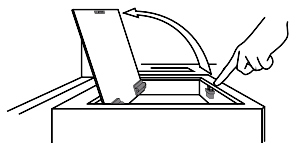

Torque Moment N-m/set

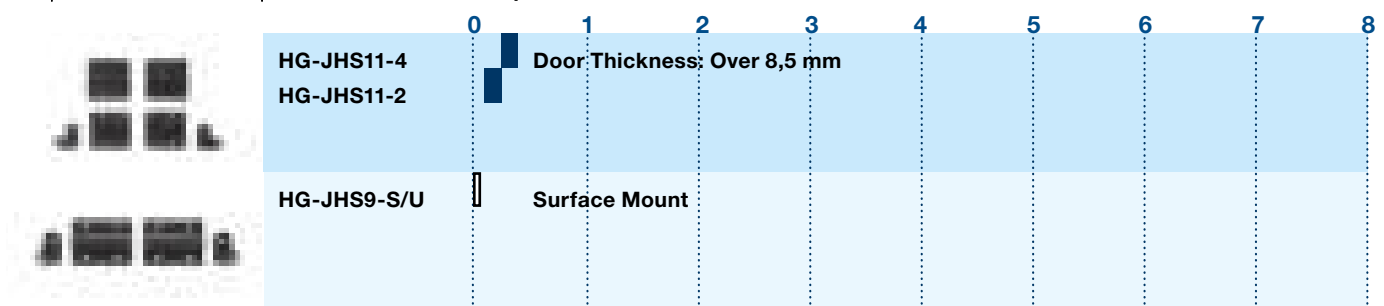



## LIFT-ASSIST DAMPER (HEAVY DUTY)

# LADH

- Heavy duty
- Ideal for counter flaps at bars, restaurants, and reception counters
- Smooth and soft close movement near closing radius prevents flaps from slamming
- Damper function works even if the flap is only opened slightly
- Suitable for door moment of 25 - 50 Nm
- Lift-assist mechanism with light opening, stops flap at 95° opening with stopper
- Available in brown or white



Product  
Link



# FEATURES

## Soft-close

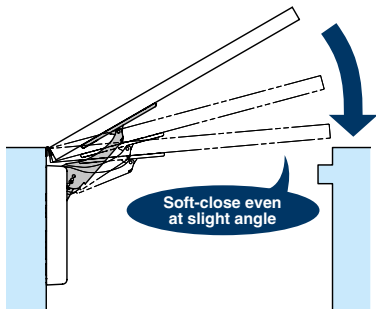

Damper works just before flap closes, preventing it from slamming shut and pinching fingers

## Lift- assist

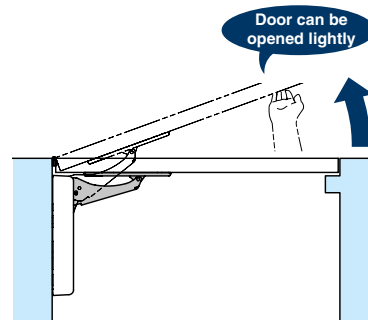

Lift-assist mechanism with light opening

## With stopper

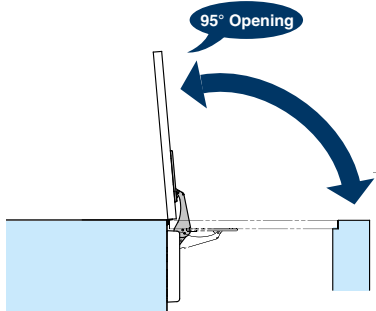

Stops flap at 95° opening

## Easy post- installation

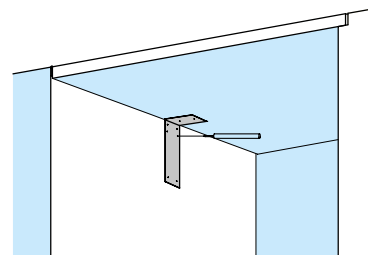

Can be retro-fitted to existing counters without processing. Simply by pressing against the supplied mounting template, installation position can be easily determined

## Door Size Ranges

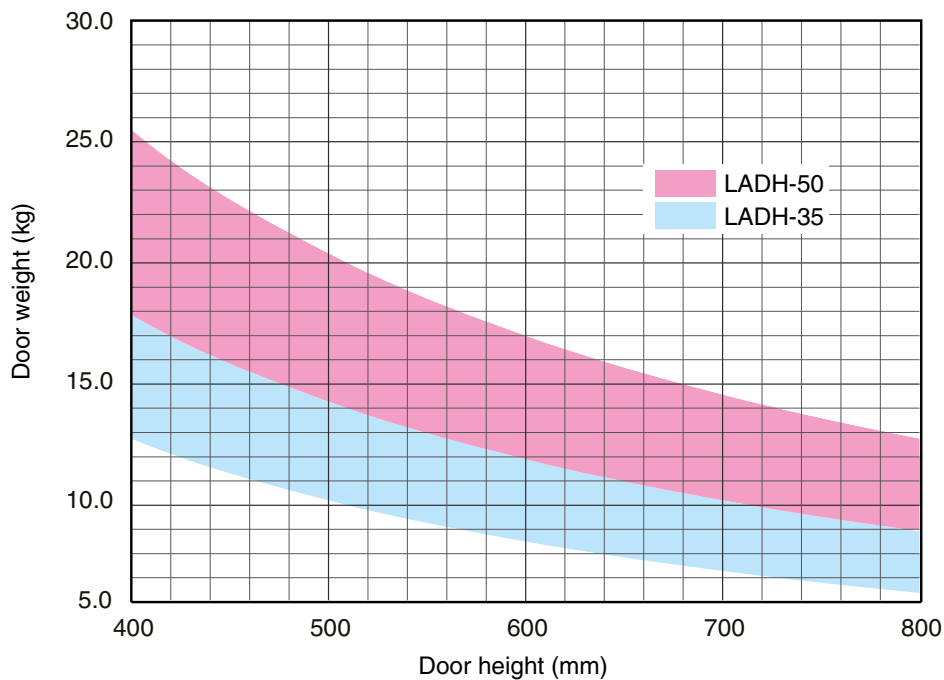



## LATERAL OPENING DOOR SYSTEM LIN-X SERIES

# LIN-X450 / 600

For small to middle sized cabinets

- Space saving: Door does not get in the way even when fully open
- Full access to cabinet interior
- Smooth closing: built-in damper gently closes the door to prevent slamming
- Easy installation: Snap-in type installation, same type of surface mounting as concealed hinge mounting plate
- Various applications including corner doors, double doors, overlapping doors



Product  
Link



# EXPLORE THE LIN-X SERIES

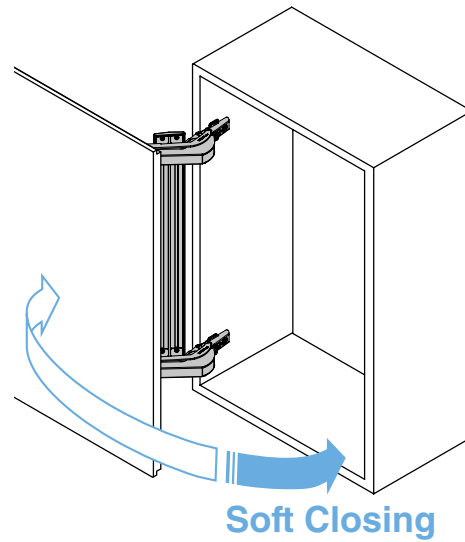
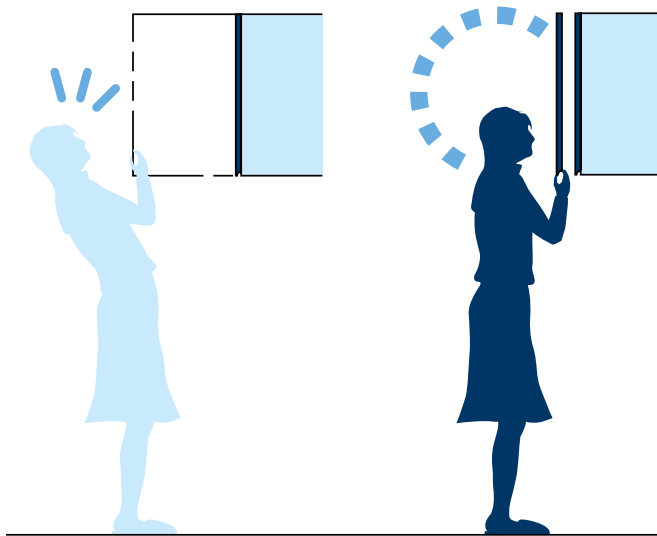

## Specifications LIN-X450

- Door Width : 400-500 mm
- Door Height: 600-2400 mm
- Door Thickness: 15-24 mm
- Door Weight : Max. 17 kg / Door
- Overlay : 19 mm
- Product specifications :  
Single door specification (Overlay)

## Specifications LIN-X600

- Door Width : 550-650 mm
- Door Height: 600-2400 mm
- Door Thickness: 15-24 mm
- Door Weight : Max. 24 kg / Door
- Overlay : 19 mm
- Product specifications:  
Single door specification (Overlay)





## LATERAL OPENING DOOR SYSTEM LIN-X SERIES

# LIN-X800 / 1000

For full-size cabinets and doors

- Door closes flush with surrounding walls for a sleek, clean design
- Space-saving with lateral movement: Compared to regular swing doors, it allows doors to swing out sideways in a small radius, ideal for narrow front space applications
- Ideal for closet entryways, large pantry doors, storage, hidden rooms, etc.
- Opens fully for access to entire cabinet
- Built-in soft-close mechanism
- 4-way adjustment



Product  
Link



# EXPLORE THE LIN-X SERIES

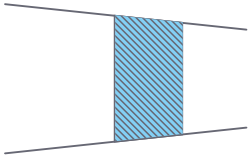

Door is fully flush with walls when closed, allowing for a flowing design.

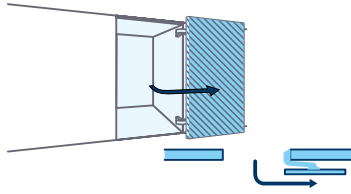

Unique movement for a compact and extremely smooth opening of the door.

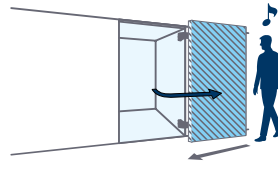

Door opens in front of the contiguous wall or cabinet, giving a full access from all directions

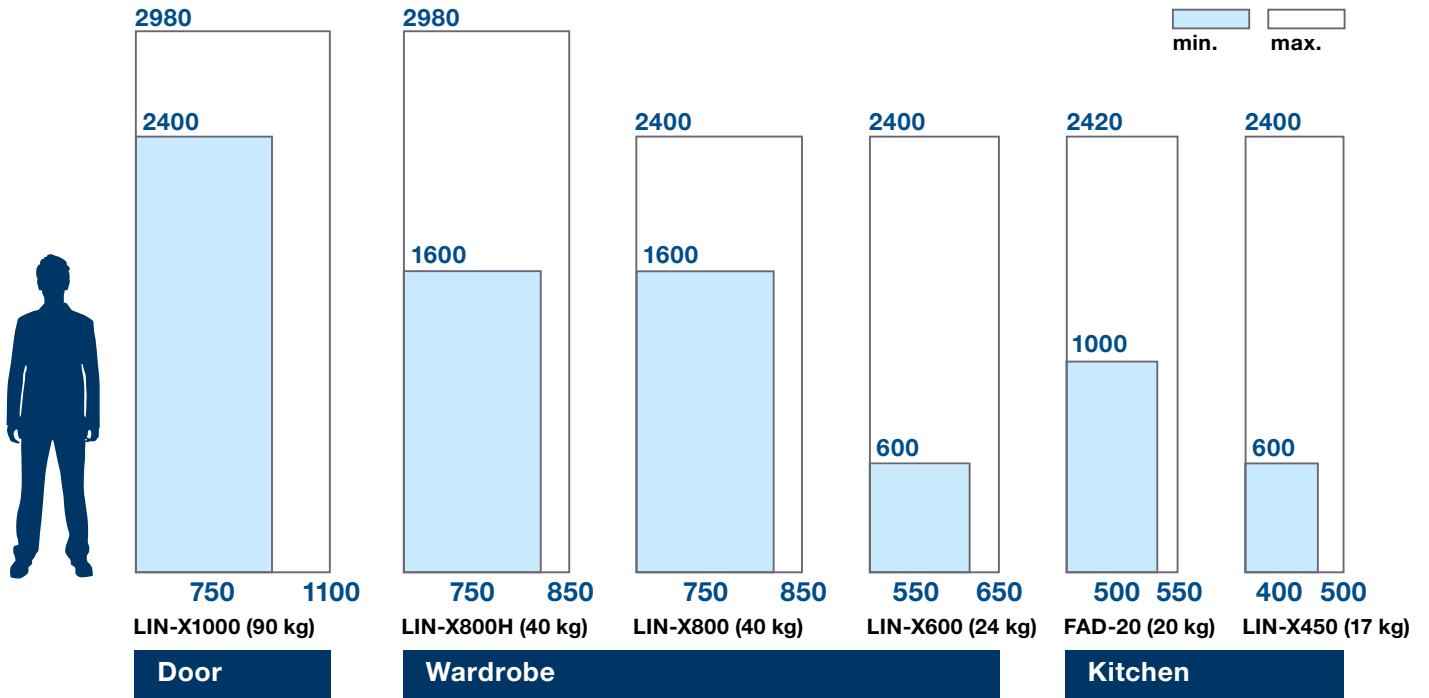
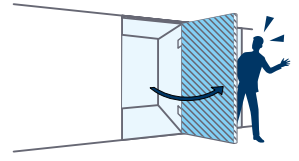



## FLUSH SLIDING DOOR SYSTEM

# MFU1200

For doors up to 70 kg

- Designed to close flush against surrounding walls, providing a sleek appearance
- Unique movement: Recesses in, and then slides sideways in a smooth continuous motion
- Clean Appearance: No floor tracks required and limited number of parts for easy installation
- Excellent performance, reliable and fully adjustable
- Features two-way damper to avoid slamming during opening or closing



Product  
Link



Video  
Link





# FEATURES



## Specifications

- Width: 800-1200 mm
- Height: max. 2700 mm
- Thickness: 30-40 mm
- Weight: MFU1200-40: 20-40 kg
- Weight: MFU1200-70: 40-70 kg
- Adjustment: Depth: +/-4 mm
- Adjustment: Height: +/-4 mm

## Remarks

- MFU1200-R-BL opens from right to left
- MFU1200-L-BL opens from left to right

## Two-way Damper

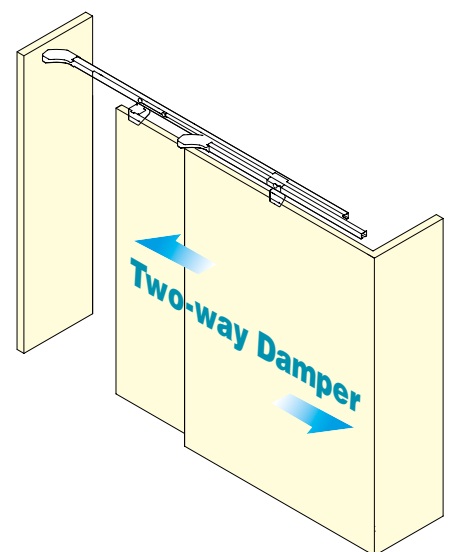



## SURFACE-MOUNT CONCEALED HINGE

# HES2S-140-A125

- Frame side surface mount for easy installation
- 125° Opening
- 3-way adjustment function allows vertical, horizontal and depth adjustment after hinge installed
- Minimum door thickness 38 mm
- Available in dark grey, light grey and black



Product  
Link



# EXPLORE THE HES SERIES

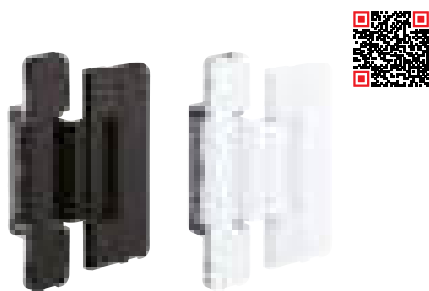

## SLIM FRAME HINGE HES1F-140

- Load capacity: 40 kgf / 2 pcs, 50 kgf / 3 pcs
- Seamlessly integrates into the slim frame for a clean and modern look
- The shaft part thickness is only 8 mm
- Doors will be flush with walls when closed



## SURFACE-MOUNT CONCEALED HINGE HES2S-140-A125

- Frame side surface mount / 125° opening
- Surface mount for door frame enables easy installation
- 3-way adjustment function allows vertical, horizontal, and depth adjustment after hinge installed

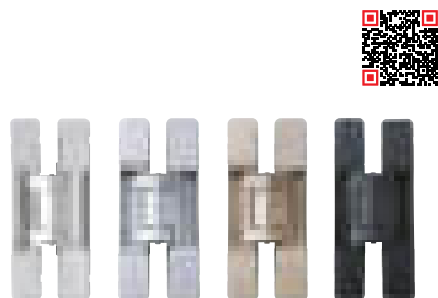

## 3-WAY ADJUSTABLE CONCEALED HINGE HES3D-E190

- Load capacity: 100 kg / 2 pcs, 125 kg / 3 pcs
- Thin profile allows for shallow mortise
- 3D adjustment post installation: Adjust vertically, horizontally, and in depth
- For simplified door hanging, the hinge divides into two parts: one for the door-side and one for the frame-side
- Can temporarily be hung before fixing with screws

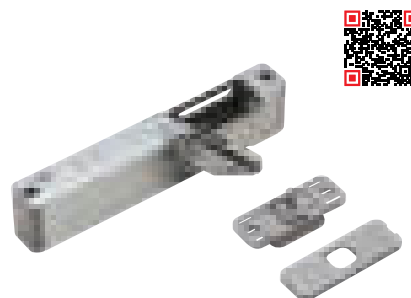

## DOOR DAMPER For Heavy Doors LDD-V100

- Unique door damper applicable to door weight up to 100 kg
- Suitable for door weight 40 - 100 kg
- Damper body is completely hidden when the door is closed
- Damper and door pull-in functions work just before the door fully closes, preventing the door from slamming shut

## 3D Door Adjustment

- Vertical:  $\pm 3$  mm
- Horizontal: +1 mm
- Depth:  $\pm 3$  mm

## Load Capacity

- 50 kgf / 2 pcs
- 65 kgf / 3 pcs

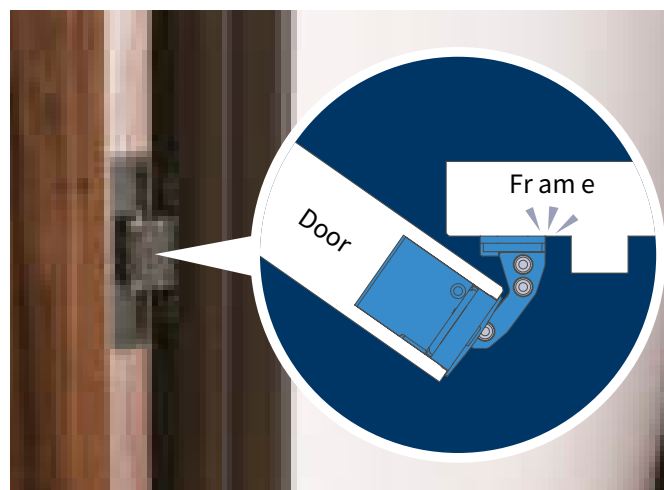



## GLASS SHOWCASE FITTINGS

# GS-G SERIES

- Total design coordination with hinges, brackets and locks in the same design
- For inset doors
- Doors can be temporarily held in frames prior to fixing screws for easy installation
- The door position can be adjusted by  $\pm 2,5$  mm right and left post installation (horizontal adjustment screw)
- The gap below the door can be adjusted from 7 up to 12 mm post installation (GS-GH50 only)



Product  
Link



# EXPLORE THE GS-G SERIES

1750 mm

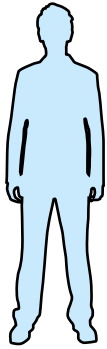

450 mm



5kg

600 mm

700 mm



20kg

1600 mm

900 mm



50kg

2500 mm

Glass thickness	Small Glass Door 5, 6 mm	Medium Glass Door 6, 8 mm	Large Glass Door 8-12.7 mm
Colour / Finish	Chrome		
	Gold (24K) Plated		
	Black		

## Easy Installation

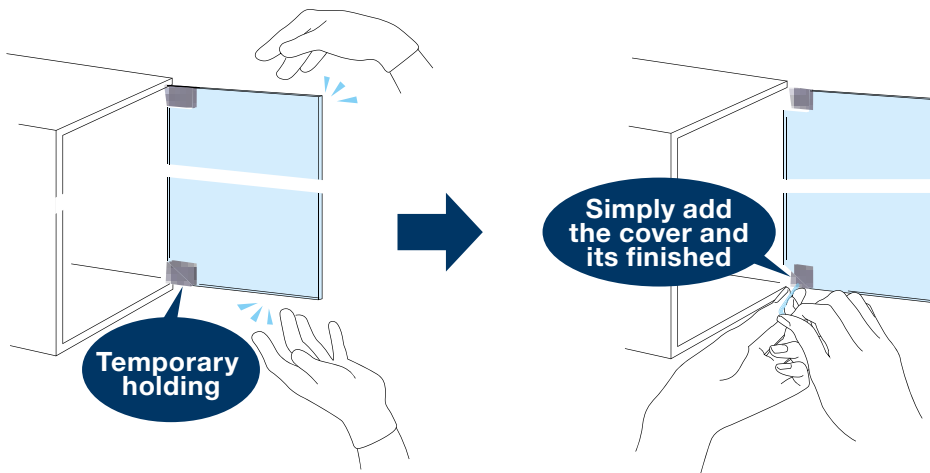

Temporary holding feature allows the door to be installed easily by one person.

The hinges and brackets can temporarily hold the glass door after they are mounted. This function makes it possible for a single person to install it easily.

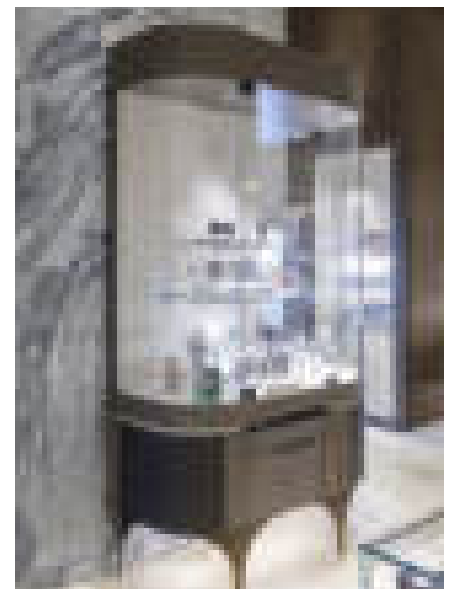



## POCKET DOOR SYSTEM

# ALT-ST

### Series for medium sized doors

- The series includes 4 models: Inset and overlay, 15 kg and 20 kg
- This pocket door system allows doors to retract inside cabinets
- Doors will not occupy space, providing full access to inside of cabinets
- With door alignment adjustability, featuring adjustable soft-close damper unit
- The hanging angle of the door can be easily adjusted: when installing, the door can be lifted upward into 5 different angles
- The door closes slowly and quietly
- The damper hinges can be replaced with hinges with catch function



**Product  
Link**



**Pocket Door System  
Selection Tool**



# EXPLORE THE ALT-ST SERIES

## ALT-ST20-D10

### Overlay / Soft Close

- Width : Max 600 mm
- Height : 800 ~ 2400 mm
- Thickness : 18 ~ 20 mm
- Door weight: up to max. 20 kg



## ALT-ST15-D10

### Overlay / Soft Close

- Width : Max 600 mm
- Height : 500 ~ 1600 mm
- Thickness : 18 ~ 20 mm
- Door weight: up to max. 15 kg



## ALT-ST20-D360

### Inset / Soft Close

- Width : Max 600 mm
- Height : 800 ~ 2400 mm
- Thickness : 18 ~ 30 mm
- Door weight: up to max. 20 kg



## ALT-ST15-D360

### Inset / Soft Close

- Width : Max 600 mm
- Height : 500 ~ 1600 mm
- Thickness : 18 ~ 30 mm
- Door weight: up to max. 15 kg



## Door Angle Adjustability

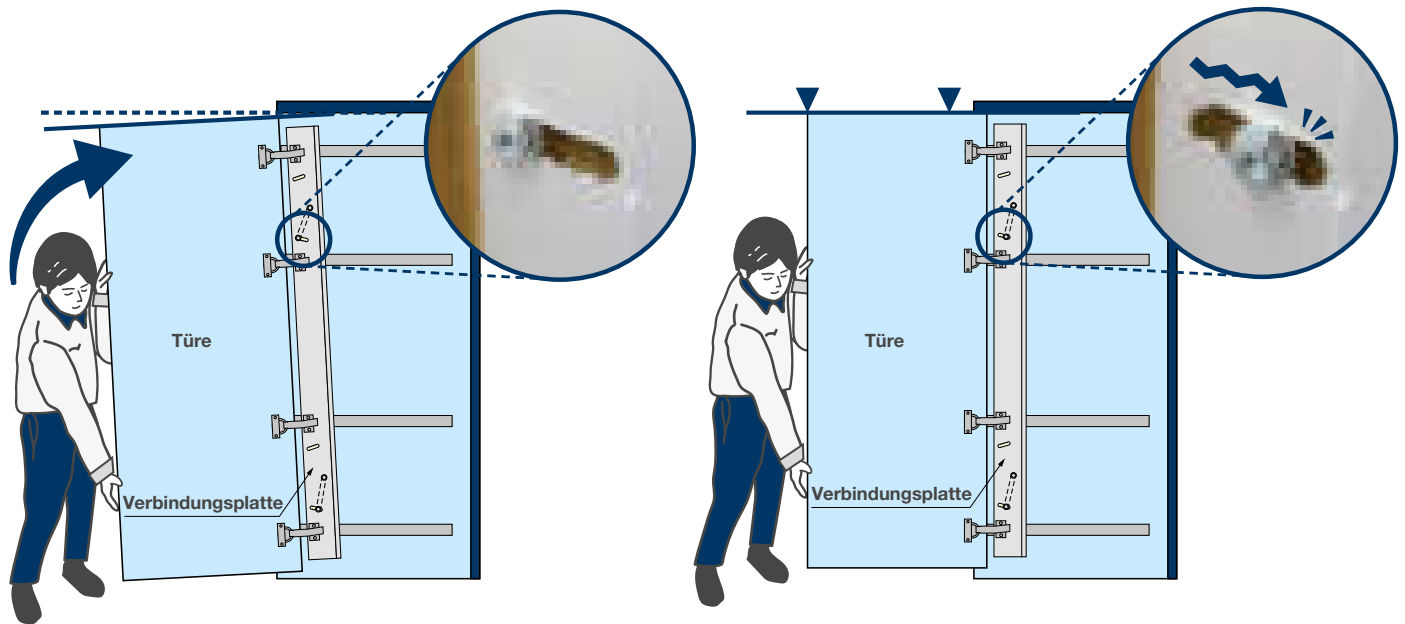

**Clean design:  
Conveniently  
stores doors  
away**





## STAINLESS STEEL FOLDING BRACKET

# EB SERIES

- Available in three sizes: EB-200, EB-303 and EB-317
- Version EB-303 and EB-317 are available with built-in damper
- Heavy duty up to 400 kg with biggest size EB-317
- Can be folded when not in use, allowing full use of space
- Automatically locks when flap is in opened position
- The lock can be easily released by pushing the lever
- Keeps in folded position and has click sound when fully closed
- No hinges are needed



Product  
Link





# FEATURES

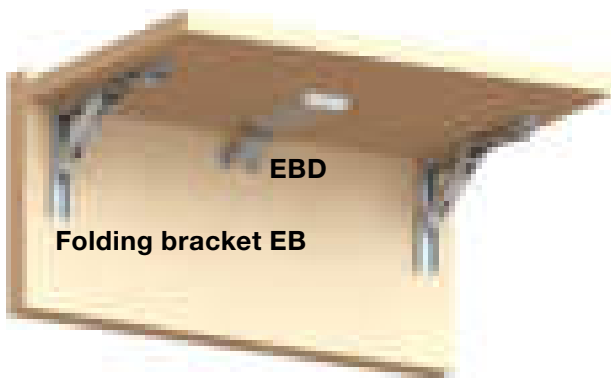

EBD

Folding bracket EB



Comes with end caps for safe use

## Optional Parts

- EBD external damper
- Folding bracket EB-DA (built-in damper)
- Interlock lever EB-90 available to unlock 2 or 3 units with one lever. Ideal for wide tables

## Remarks

- Use a long screwdriver for installation EB-303, EB-303-BL, EB-317, EB-317-BL
- Make sure the release lever is attached to bottom of the shelf for correct installation
- Please make sure the wall can sustain the load



## STAINLESS STEEL MULTI-PURPOSE LID

# AZ-GD

with damper

- AZ-GD230-BL and AZ-GD310 also available in durable black coating
- Suitable for a variety of commercial, residential and marine applications
- With built-in damper
- Installed with anti-pinching plates
- Stainless steel (SUS304)
- Available in four sizes



Product  
Link



# AZ-AT

## with sensor

- The lid opens automatically when the sensor detects a hand. Thanks to its hands-free use, it is perfect for public areas and the medical sector.
- Sensing distance can be adjusted up to 300 mm with dial on back
- Turn the sensor off to disable automatic opening / closing (green light in sensor part normally lit)
- With soft-closing function
- Plates on both sides of the opening offer protection against hand pinching
- Can be opened and closed manually in the case of a power failure



Product  
Link

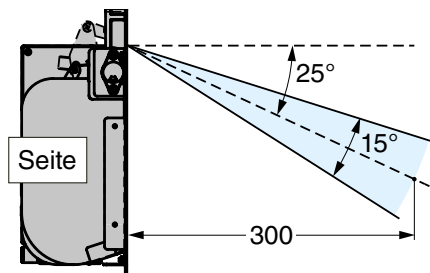
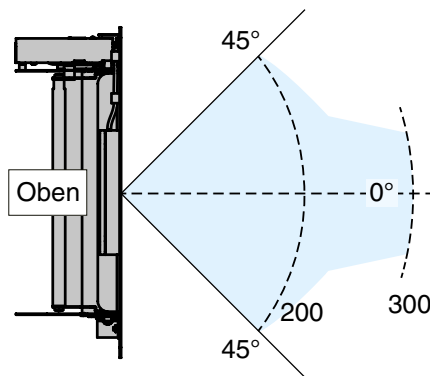

## Specifications AZ-AT with sensor

- Passed 150,000 private cycle open / close tests
- Material: Stainless Steel (SUS304)
- Finish: Satin
- Operating temperature: 0°C~40° C

## Recommended AC Adaptor

- Output DC15V 1.6A, center positive



## LIFT-ASSIST LID STAY WITH SOFT CLOSE

# ARN-2

## Top opening

- Available for top or upward opening (ARN-3 type) as M or H type depending on lid dimensions
- Smooth door movement
- It is specially designed for use with the OLYMPIA concealed hinge: 360-D26-19 / H360-D26-26T
- The lift-assist function allows for light opening of doors (adjustable)
- The soft-close function makes doors close gently (0°-30° degrees) (adjustable)
- Board thickness: Min: 15 mm ~ Max: 22 mm
- Available in Nickel / Black and Nickel / Grey



**Product  
Link**



# FEATURES

**ARN-3 for Upward Opening  
also available**

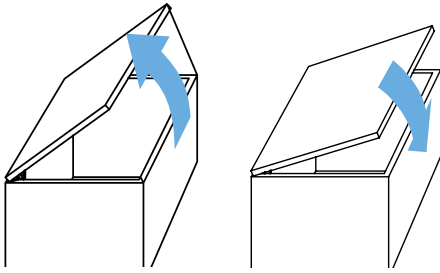

Light opening

Gently closing



## Standard Set

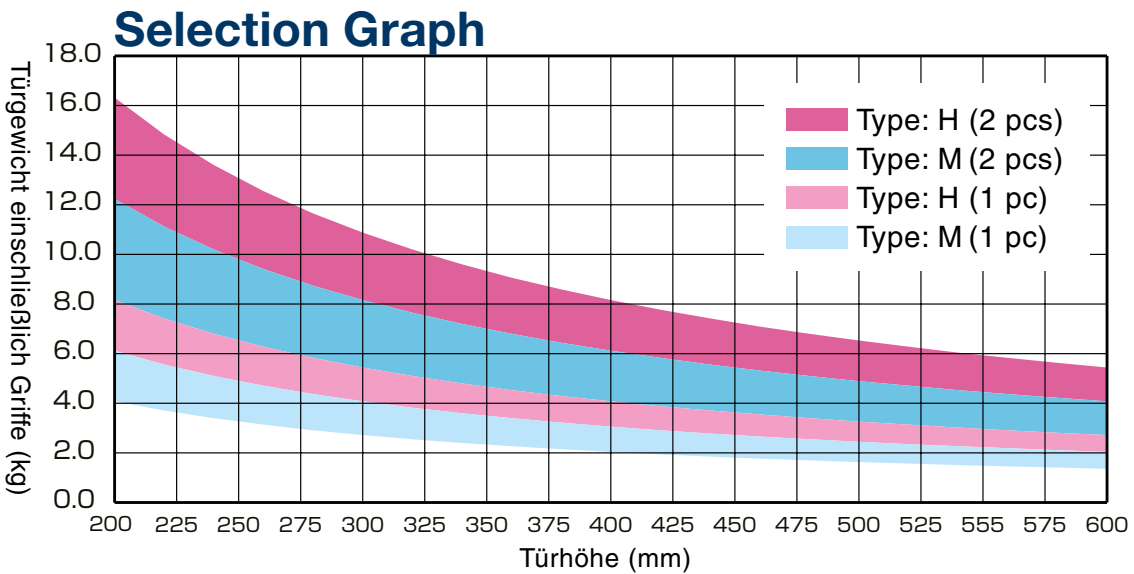
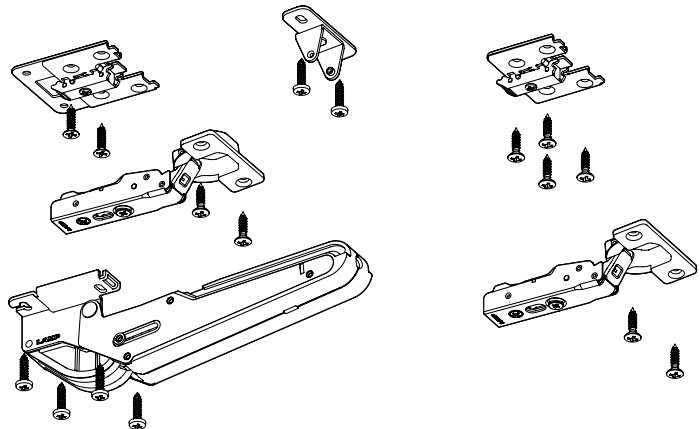
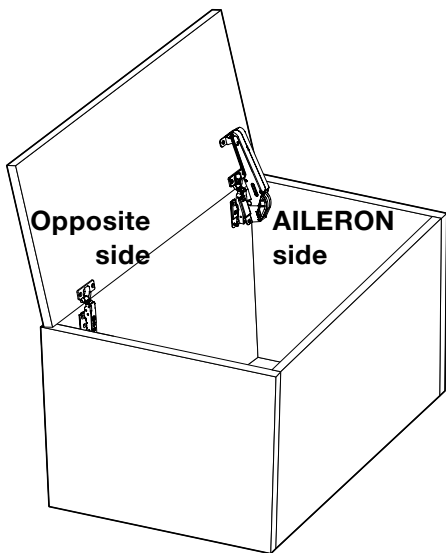



## CONCEALED HINGE (STAINLESS STEEL)

# 180SUS

- Soft Close
- 3D adjustment: Depth:  $\pm 2$  mm (from centre of long hole), vertical:  $\pm 2$  mm (from centre of long hole), overlay:  $\pm 2$  mm (at 5 mm cut and 17 mm cover)
- Sold separately: stainless steel mounting plate
- Recommended: Countersunk or round countersunk head wood / tapping screw 3.5
- All parts of the hinge, excluding the damper, are made of stainless steel



Product  
Link



Picture above is the combination of  
concealed hinge and mounting plate

# 180SUS-P6T

## Mounting Plate

- Mounting plate for 180SUS concealed hinge
- Made of stainless steel



Product Link

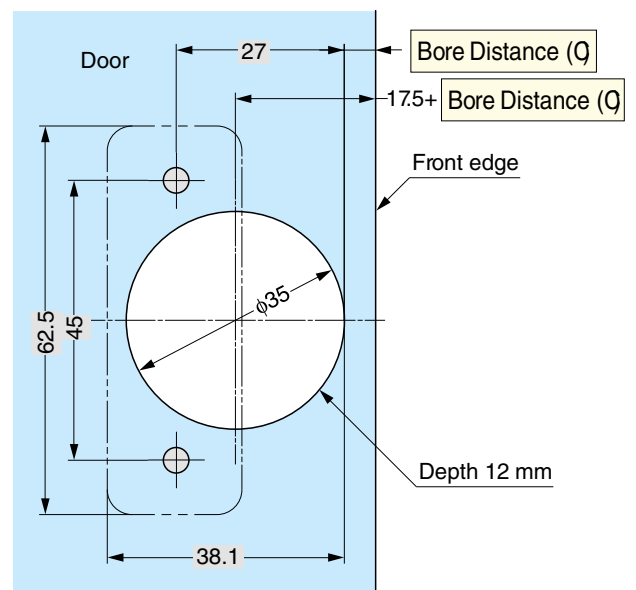
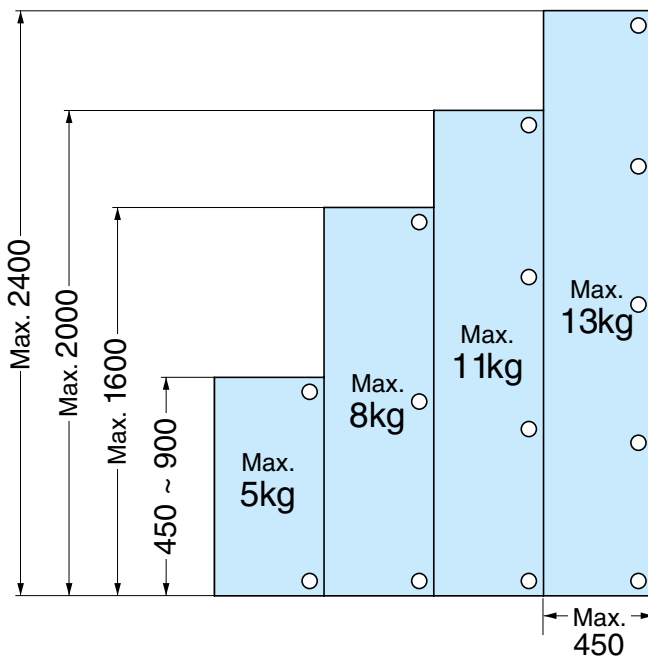
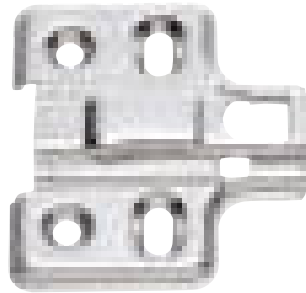

## Door size and recommended hinge quantity

- The number of hinges mounted varies according to the door dimensions. For doors of the same weight, a larger distance between the upper and lower hinges will enhance strength
- Generally, when using 3 hinges, the intermediate hinge should be a little higher than the centre point between the upper and lower hinges for enhanced strength
- Note: Use the figure only as a guideline



## NON-MAGNETIC TOUCH LATCH

# MC-37F

- Passed 100,000 open / close private cycle test
- One push open / close operation removes the need for handles and pulls
- Counter plate can move within a 3 mm diameter area post installation, making adjustment simple
- Unique “claw” design for a strong retaining force of 8 kg



Product  
Video



Product  
Link

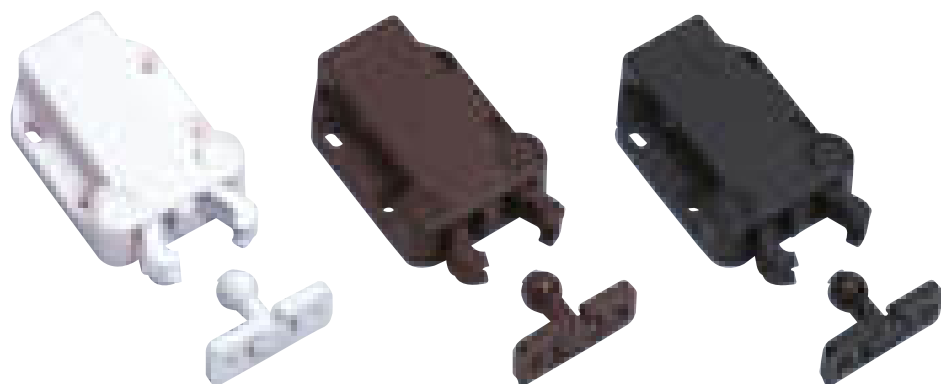



# FEATURES



## Ideal for campers and boats

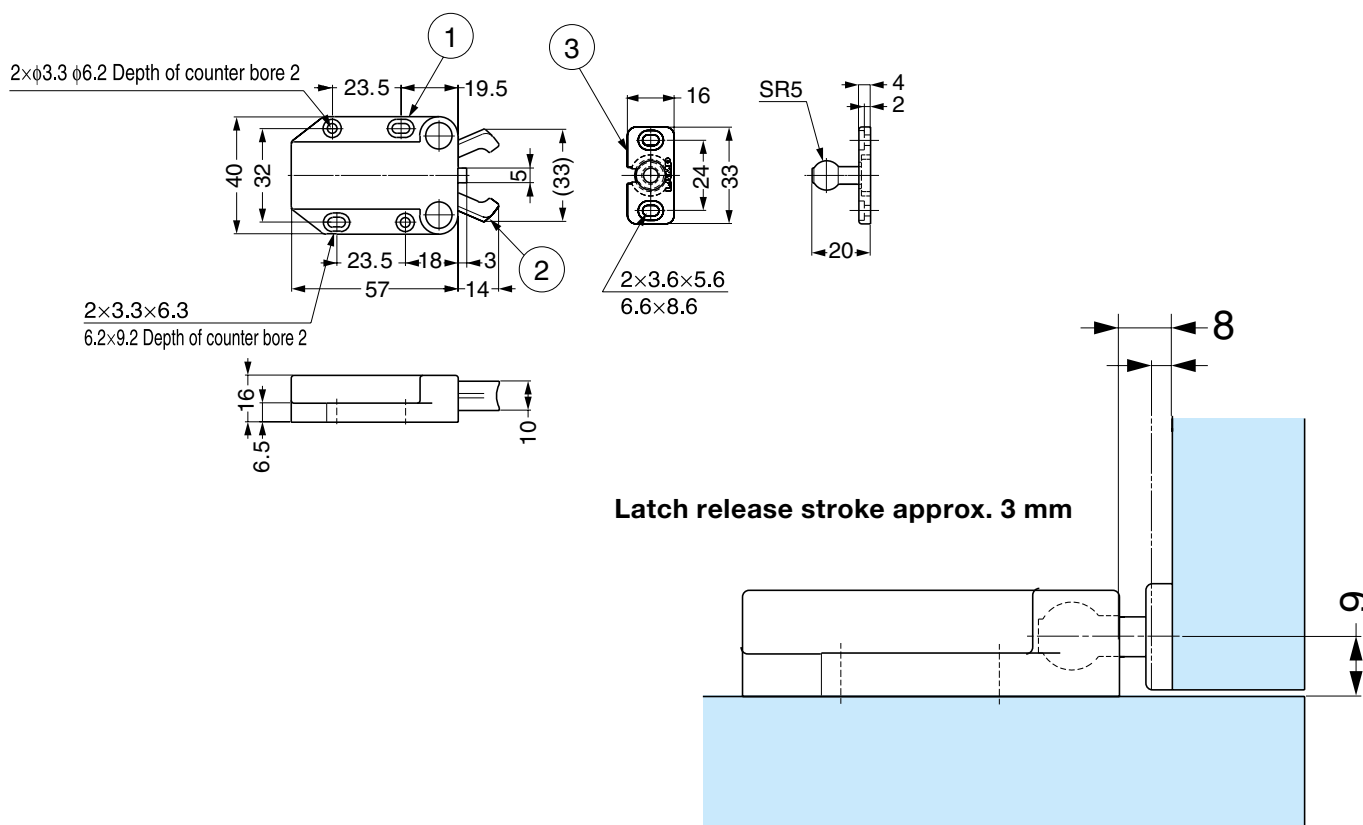

## Specifications

- Parts Included: Round head wood screw 3.5 x 10, 3.1 x 13
- Retaining Force: 8 kgf
- Colours available: black, brown, white
- Material Body: ABS
- Material Arm: Polyacetal (POM)
- Material Counter Plate: Polyamide (PA)

# HOOKS

STAINLESS  
316  
STEEL



STAINLESS  
316  
STEEL



## FRICTION SWIVEL LATCH HOOK EN-R100F

- Hook clip springs back automatically to prevent unintended release
- Swivel with friction to prevent unnecessary movement
- Can hold ropes or chains with a diameter of up to 16 mm

## LATCH HOOK EN-E107

- Pushing down on the front of the latch causes the latch opening to open upward. Detaching is very quick and easy
- Items can be hooked simply from the top

STAINLESS  
304  
STEEL



STAINLESS  
304  
STEEL

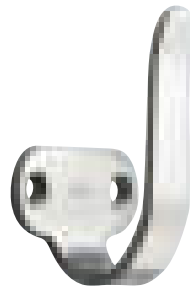

STAINLESS  
316  
STEEL



## LARGE UTILITY HOOK JF45M, JF70M, JF110M

- Large size hooks that can be used to hold items that previously needed to be placed on the floor
- Mirror finish with attractive shine

## HOOK 2H

- Also can be used as a pull
- 2.5 mm thick stainless steel with rounded edges for safety
- Stainless steel screws included

## HOOK EU

- Can hold 3 items at the same time, using the neck of the hook with the 2 hook ends
- Double tipped shape well suited for hanging items like hats and capes

STAINLESS  
304  
STEEL



STAINLESS  
304  
STEEL



## HOOK HJ

- Ideal for coffee shop table or under a shelf
- 3 sizes available
- Black colour (matte) is newly launched

## COUNTER HOOK HK-CH35

- With Soft Closing Mechanism
- When not in use, the hook will automatically retract
- When retracted, the arm will be visible from the sides of the table

## ROTATING HOOKS RF-50S

- Ideal for coffee shop table or under a shelf
- Can hold 2 bags at the same time
- Rotates 360 degrees

STAINLESS  
304  
STEEL

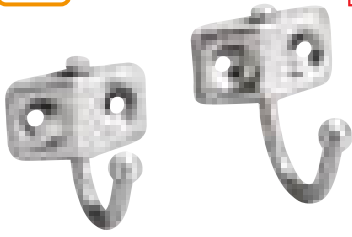

### SWING HOOK TK, TKF

- Hook can rotate 180° to save space when not in use
- Friction type prevents unintended position change due to vibrations
- Hook has ball end to make it safer

STAINLESS  
304  
STEEL



### WIRE HOOK TL

- Hook has ball end to make it safer
- Flange allows for perfectly lined up installation
- Made from one single piece of wire for flawless finish

STAINLESS  
304  
STEEL



### WIRE HOOK TY

- Hook has ball end to make it safer
- Flange allows for perfectly lined up installation
- Made from one single piece of wire for flawless finish



### RECESSED HOOK NF-R

- The arm section is sprung powered and automatically folds back in when no force is exerted on it
- There is no protrusion when the arm is folded in, creating a neat design and ensuring safety



### RECESSED HOOK NF-K

- The arm section is spring powered and automatically folds back in when no force is exerted on it
- The product does not protrude when the arm is folded in, creating a neat design and ensuring safety



### RECESSED HOOK NF-60D

- Soft and self-closing
- End of arm is equipped with small protrusion to prevent items from falling off
- Little protrusion when close, making it safer and visually appealing



### DOUBLE HOOK PXB-GR05-211

- Covered with soft silicone rubber, this series has a charming rounded shape
- Stainless steel base for higher load capacity and corrosion resistance

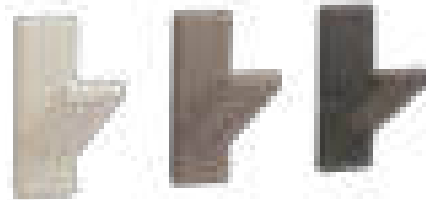

### SILICONE HOOK PXB-GN05-111

- Screw Mount/Large Size
- Simple design with several safety features
- Base made of SUS304 provides high durability
- Designed to work in many different kinds of interiors

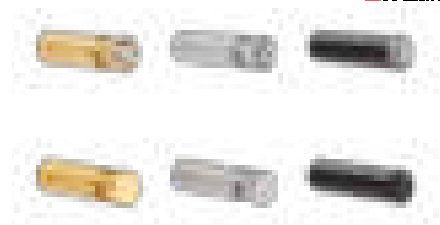

### VANITY HOOK SSF-10

- Hook has ball end, making it safer to use
- Available with Swarovsky® crystal
- Ideal to hand small accessories such as shoe horn

# CATCHES & LATCHES



## PUSH KNOB LATCH DPL-RO

- When the knob is pushed in, the product becomes flush with its surroundings for a safe and smart design
- Pushing the knob in while the door is closed will lock it. Pushing the knob again will unlock it.



## PUSH KNOB LATCH PKL-08

- When the knob is pushed in, the product becomes flush with its surroundings for a safe and smart design
- Pushing the knob in while the door is closed will lock it. Pushing the knob again will unlock it.



## METAL MAGNETIC TOUCH LATCH ML-ZN80

- The body is made of metal for high durability
- Designed for use on large doors due to its strong push force



## MAGNETIC TOUCH LATCH ML-120

- No handle needed, just push to open / close
- The rotary cam mechanism offers a longer life than the usual spring mechanism

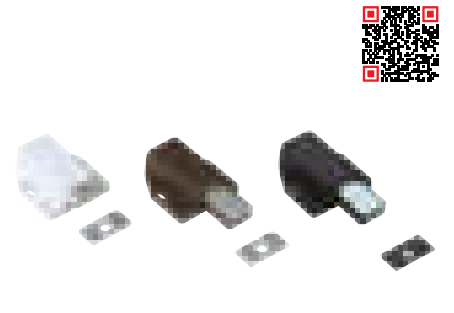

## MAGNETIC TOUCH LATCH ML-80

- No handle needed, just push to open / close
- The rotary cam mechanism offers a longer life than the usual spring mechanism



## NON-MAGNETIC TOUCH LATCH MLC-100

- 2 mm vertical adjustment
- Push latch with long stroke
- One push open / close operation removes the need for handles and pulls
- Non-magnetic type



## NON-MAGNETIC TOUCH LATCH MC-37F

- One push open/close operation removes the need for handles and pulls
- Passed 100,000 open / close cycles in a private test
- Self-adjusting mounting plate for easy installation

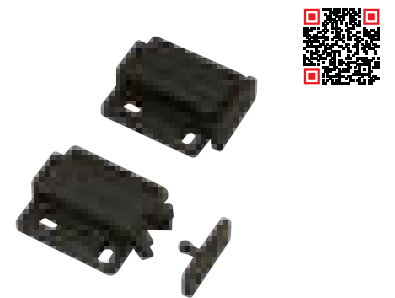

## NON-MAGNETIC TOUCH LATCH MC-28

- One push open/close operation removes the need for handles and pulls
- Non-magnetic
- Self-adjusting mounting plate for easy installation



**NON-MAGNETIC MINI TOUCH LATCH  
ESN-195/BLK**

- Quick installation
- Compact body with strong retaining force
- Easy snap-in installation
- One push open / close operation removes the need for handles and pulls

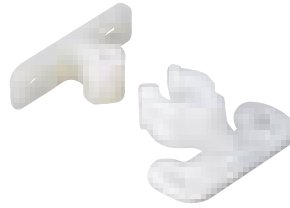

**KNUCKLE CATCH  
NAC**

- Powerful retaining force suitable for use on larger doors
- Simple structure is highly durable
- Can be used on both overlay and inset doors



**ROTARY CATCH  
RC6900, RC6901**

- Resin body prevents rusting
- Strong retaining force
- Passed 100,000 open / close cycles in a private test
- Can be used on both overlay and inset doors

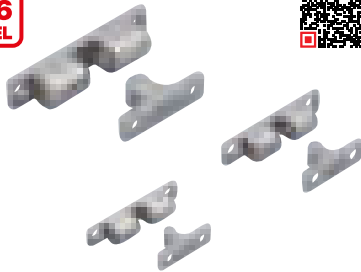

**TENSION CATCH  
BCTS**

- Can be installed vertically or horizontally
- High corrosion resistant SUS316
- Tension is not adjustable



**STAINLESS STEEL LEVER LATCH  
LL-66S**

- Made entirely out of SUS316 or its equivalent. Very high corrosion resistance
- For use on overlay doors where the door is longer than the cabinet
- Removes the need for handles or pulls
- High resistance to vibrations from movement or from earthquakes



**LEVER LATCH  
LL-66**

- Chrome finish has been newly added
- For use on overlay doors where the door is longer than the cabinet
- Removes the need for handles or pulls
- High resistance to vibrations from movement or from earthquakes

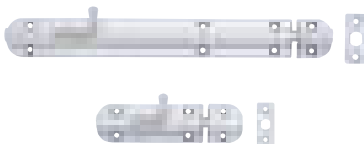

**SPRING LOADED BARREL BOLT  
BSS**

- Ideal for harsh and high corrosion environments
- Knob springs back into sleeve to keep bolt in locked or unlocked position
- 2 counter plates included for different mountings

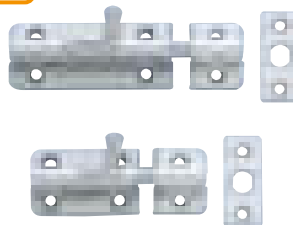

**SPRING LOADED BARREL BOLT  
BL-S**

- Ideal for harsh and highly corrosive environments
- Knob springs back into sleeve to keep bolt in locked or unlocked position
- 2 counter plates included for different mountings



**LEVER BOLT  
HR35**

- Ideal for harsh and high corrosion environments
- Turn the latch knob to open / close
- Easy installation, flat and compact design for various application
- 2 different counter plates included for different mountings

# CATCHES & LATCHES



## MAGNETIC CATCH MC-YC-06

- Compact type
- Strong die casted body
- Small body with strong magnetic force
- Can be installed vertically or horizontally



## MAGNETIC CATCH MC-YS

- Ultra thin magnetic catch ideal for tight space
- Extra strong magnetic force: MC-YS001, MC-YS001P
- Weaker magnetic force: MC-YS002, MC-YS002P

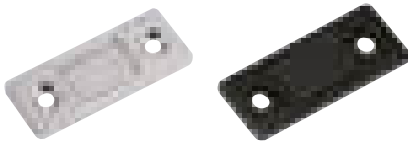

## MAGNETIC CATCH MC-159

- Strong Force / Ultra-thin
- 3 mm ultra thin magnet operates well even in tight spaces
- Extremely strong magnetic force
- Similar items with different magnetic forces: MC-158, MC-159, MC-159-SUS

## MAGNETIC CATCH MC-159-SUS

- Ultra-thin / Stainless Steel
- 2.8 mm ultra thin magnet operates well even in tight spaces
- Covered with an acrylic resin coating for better corrosion resistance
- Very strong magnetic force

## MAGNETIC CATCH MC-YN001, MC-YN001P

- Ultra-thin
- 2.2 mm ultra thin magnetic catch operates well even in tight spaces
- Very strong neodymium magnet
- Available with or without counter plate

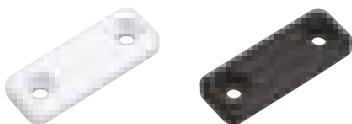

## SEALED MAGNETIC CATCH MC-JM45

- Resin body prevents rusting
- Thin magnetic catch ideal for tight space
- Ideal for kitchen equipment by using with the counter plate MC-JMP45

## SEALED MAGNETIC CATCH MC-JM50

- For wet area
- Resin body prevents rusting
- Ideal for kitchen or bath equipment by using with the counter plate MC-JMP45

## COUNTER PLATE MC-JM49

- Stainless Steel
- Counter plate for MC-JM magnets
- Good corrosion resistance

# HANDLES PULLS & KNOBS



## ALUMINIUM DOOR HANDLE SOR

- Flowing curves that adapt gracefully to any surface
- Other handle sizes are available. Please contact us for lot size and prices

## SOFT SILICONE HANDLE PXB-GR09

- Brighten spaces with this simple, yet soft silicone-covered handle that comes in a variety of fun and vivid colours
- The cover and base are integrated and cannot be separated

STAINLESS  
316  
STEEL

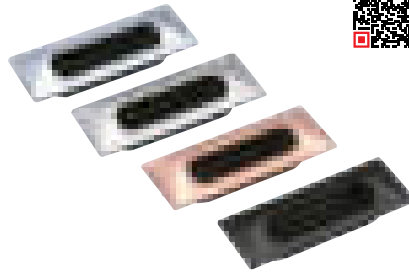

## STAINLESS STEEL RECESSED PULL HH-DS114

- Parts included:
- For wood panel t = 20: truss head tapping screw M4 × 15 (SUS)
- For sheet metal t = 2: truss head tapping screw M4 × 8 (SUS)

## RECESSED PULL UTZ-130

- Truss head screw M4 × 8 included
- Spacer for sheet metal applications
- Available in for finishes, including black

## RECESSED LEVER PULL FH-100AM, FH-100BM

- FH-100AM stays open when lever is released
- FH-100BM closes automatically when lever is released
- Recommended for doors over 25 mm thick

STAINLESS  
304  
STEEL



STAINLESS  
304  
STEEL

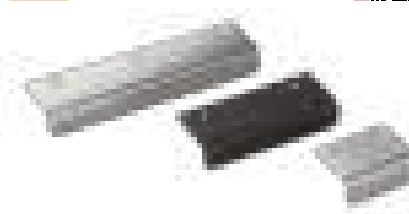

## STAINLESS STEEL HATCH PULL HR

- Ideal for floor traps and inspection hatches
- In stainless steel for corrosion resistance

## STAINLESS STEEL PULL SN

- Flat handle for clean design
- Available in 7 sizes and 3 finishes
- Brass version available with SNB handle

## KNOB EXSEL

- Light weight aluminium knob
- Available in 4 sizes and 2 finishes, including black
- Installation screws are included

# HINGES

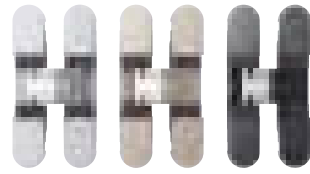

## 3-WAY ADJUSTABLE CONCEALED HINGE HES3D-70

- Small HES series can be applied with Min. door thickness of 19 mm
- 3-way adjustment function allows vertical, horizontal, and depth adjustment after hinge installed
- Hinge can be split into the door side and the frame side



## 3-WAY ADJUSTABLE CONCEALED HINGE HES3D-90

- Thin profile allows for shallow mortise and makes installation easier
- Vertical, horizontal and depth adjustment possible post-installation (3-way)
- Can be split into two parts (one for the frame and one for the flap) making installation easy

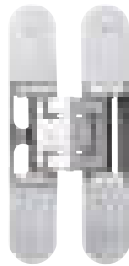

## STAINLESS STEEL CONCEALED HINGE HGS3D-S160SH

- With 3-way adjustment function
- Stainless steel construction with excellent corrosion resistance
- The hinge can be split into two parts (door and frame sides)

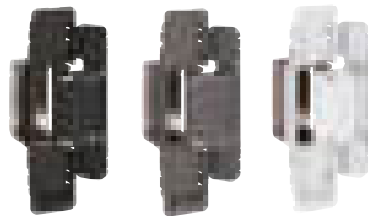

## SURFACE-MOUNT CONCEALED HINGE HES2S-140-A125

- Surface mount for door frame enables easy installation
- 125° Opening
- 3-way adjustment function allows vertical, horizontal, and depth adjustment after hinge installed

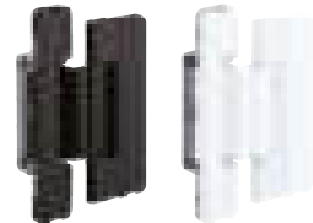

## SLIM FRAME HINGE HES1F-140

- Seamlessly integrates into the slim frame for a clean and modern look
- Doors will be flush with walls when closed
- 3-way adjustments can be made post installation
- The doors can be provisionally hung on frame before fixing

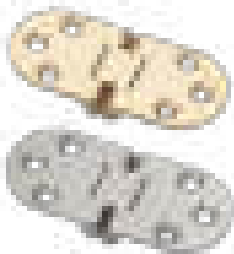

## TABLETOP HINGE MH-30

- Double pivot hinge allows 180 degrees opening
- Brass with 3 different finishes
- Max load capacity: 4 kg per pair



## DROP HINGE SDH-P

- Adjustable type
- 3-way adjustment
- Overlay: 16-19 mm / Horizontal: +/-1mm / Door gap: 1-3 mm
- Can be used with soft-down stay SDS-100, SDS-100TV, NSDX-10



## PIVOT TORQUE HINGE HG-PTH30

- No tools are needed to attach and detach doors, allowing for easy maintenance
- Ideal for interior sunshade application
- Torque allow for the flap to stay in place



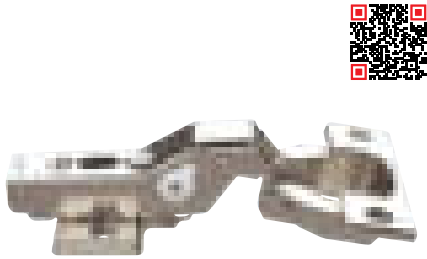

### CONCEALED HINGE H360

- Cup size 40 mm
- For doors up to 34 mm thick
- 5-steps damper adjustment
- 3D adjustable

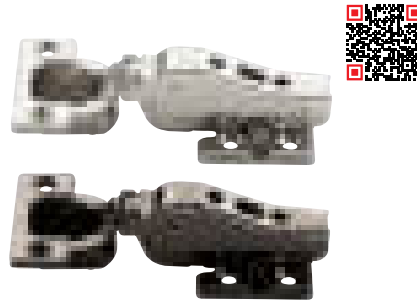

### HEAVY-DUTY CONCEALED HINGE J95

- Max. door weight: 25 kg with 2 pcs, 40 kg with 3 pcs
- For doors up to 900 mm wide
- 3-way-adjustment function by mounting plate (depth + 1.5, - 2.5 mm, vertical +/- 3 mm, overlay [horizontal] +0, -4 mm)



### WIDE-ANGLE HEAVY-DUTY CONCEALED HINGE J160

- 160° opening / Built-in damper
- The built-in damper allows doors to close slowly providing premium door motion
- Max. door weight: 25 kg with 2 pcs, 40 kg with 3 pcs
- For doors up to 900 mm wide



### INSET GLASS DOOR HINGE GH34-0

- For inset doors
- Hinge for glass / acrylic doors
- For glass 4-6 mm thick
- Stainless steel version also available
- Overlay version GH34-8 also available



### INSET GLASS DOOR HINGE XL-GH03-48-0

- For inset doors
- Hinge for medium size glass / acrylic doors
- For glass door 5,6 and 8 mm thick
- Overlay version XL-GH03-48-8 also available



### GLASS HINGE GS-GH20

- For inset glass doors
- Temporary holding feature allows the door to be installed easily by one person
- Sideways adjustment ( $\pm 2.5$  mm) possible after installation of the door



### LIFT-OFF HINGE KN

- Handed: Specific left and right hand mounting
- Stainless steel for corrosion resistance
- 3 sizes available
- For flaps up to 15 kg per pair



### INSET DOOR PIVOT HINGE PP-60

- For inset doors
- Handed: Specific left and right hand mounting
- Hinge installed below and above the door for better design
- 180° degrees opening possible



### SELF-OPEN DAMPER HINGE HG-JHS11

- Self and soft opening hinge for push to open flaps
- Opening speed is adjustable with a hex key
- Applicable into surface mount with Bracket UKZ11-BL (sold separately)

# LID SUPPORTS

STAINLESS  
303  
STEEL

STAINLESS  
304  
STEEL



## ULTRA MINI LID STAY L-100S, L-140S

- Door flap locks in opened position to release, push door flap into fully opened position
- When closed, the extendible section of the arm is stored inside the body, allowing the cabinet interior to be used effectively
- Optional bracket L-S-BT available

STAINLESS  
304  
STEEL

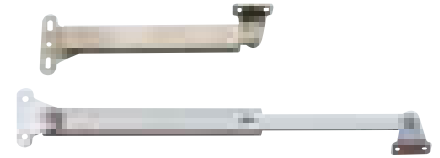

## SELF-OPENING STAY L-195, L-270

- For use in pairs
- Self & soft open
- Opens automatically if flap is pulled open slightly
- Built-in damper causes flap to open gently, preventing slamming
- Built in catch to hold flap when fully closed



## COMPACT SOFT-DOWN STAY CSD-10-TV

- Easy installation type
- Soft-down stay for downward-opening flap doors. Works well with short flapdoors
- Simple installation by just aligning the stay with the sides and fastening with screws (For single axis hinges and drop hinges)



## ADJUSTABLE SOFT-DOWN STAY NSDX-10(R/L)

- For downward-opening flap doors
- Can also be used with piano, butt, or drop hinges
- Built-in catch holds flap in closed position
- Opening speed adjustable



## SOFT-DOWN STAY SDS-100, SDS-C100

- Soft down
- For downward-opening flap doors
- Built-in damper causes flap to open gently near fully open radius
- Non-handed



## SELF-OPENING STAY HDS-10S

- Use in pairs
- For downward opening flap doors
- Self closes if given a small push in opened position
- Equipped with damper to close gently and prevent slamming

STAINLESS  
430  
STEEL



## HEAVY DUTY SPRING LOADED LID STAY S-AT

- Side panel mount
- Lift assist: makes lids feel lighter and easier to open
- Compact design allows interior to be used effectively



## ADJUSTABLE SOFT-DOWN STAY NSDX-20(R/L)

- For top-opening flap doors
- Built-in damper causes flap to close gently preventing slamming
- Built-in catch holds flap in fully opened position position



### **AILERON STAY FOR OLYMPIA ARN-2**

- Top opening
- Specially designed for use with the OLYMPIA hinge
- The lift-assist function allows for light opening of doors
- The force of lift-assist is adjustable



### **SELF-OPENING STAY HDS-20S**

- Top opening
- Opens automatically if flap is pulled open slightly
- Built-in damper causes flap to open gently, preventing slamming
- Can also be used with single axis hinges like concealed, piano or butt hinges

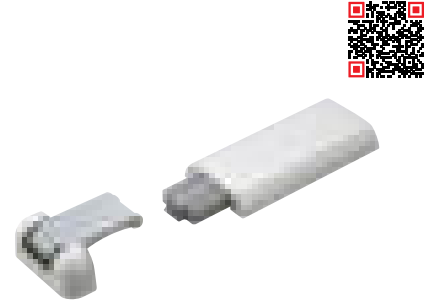

### **LIFT-ASSIST DAMPER LAD**

- Great solution for counter flaps at bars, restaurants, and receptions
- Built-in damper provides soft closing near closing radius, preventing slamming
- Lift-assist makes counter flaps feel light and easy to lift



### **ADJUSTABLE SOFT-DOWN STAY NSDX-35(R/L)**

- For upward-opening flap doors
- Built-in damper causes flap to close gently preventing slamming
- Built-in catch holds flap in fully opened position



### **SOFT-DOWN STAY SDS-C301N**

- For upward-opening flap doors
- Works well with short flap doors
- Built-in damper causes flap to close gently
- Non-handed



### **AILERON STAY FOR OLYMPIA ARN-3**

- Upward Opening
- Specially designed for use with the OLYMPIA hinge
- The lift-assist function allows for light opening of doors
- The force of lift-assist is adjustable



### **DISK DAMPER UDD**

- Passed 30,000 cycles in a private test
- Ideal for bakery applications
- Simple design integrates well with frames for a sleek design



### **OVER THE TOP FLIPPER DOOR MECHANISM**

- OV-1**
- For upward-opening flap doors
- Built-in damper provides soft closing near closing radius, preventing slamming
- When pulling the flap door out horizontally, will hold its position



### **INSET RECEDING DOOR MECHANISM IF**

- Pocket door system for space saving
- Ideal for home office applications
- For upward-opening flap doors
- Built-in damper provides soft closing near closing radius, preventing slamming

# DRAWER SLIDES

STAINLESS  
304  
STEEL



STAINLESS  
304  
STEEL



## MINI SLIDE SCRW2

- 2-WAY
- 3/4 extension (2 members)
- Ultra slim profile
- Special inner member allows smooth movement
- The drawer can be moved to both directions

## MINI SLIDE SCR3

- Full extension
- Ultra slim profile
- Special inner member allows smooth movement



## ALUMINIUM MINI SLIDE ARW2-16

- 2-WAY
- 3/4 extension (2 members)
- The drawer can be moved to the both directions
- Thin profile for light applications
- Light-weight aluminium body

## ALUMINIUM MINI SLIDE AR3-16

- Full extension (3 members)
- Thin profile for light applications
- Light-weight aluminium body

## FULL EXTENSION SLIDE AR3-K

- With hold-out detent
- Full extension (3 members)
- Non-handed
- The drawer can be held in the fully opened position

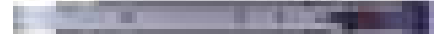

## FULL EXTENSION SOFT-CLOSE SLIDE 4670

- Black
- Self and soft closing slide.
- Full extension (3 members)
- With a bumper to avoid metal-to-metal noise at the end of the course
- The drawer is detachable by lifting the lever

## FULL EXTENSION SOFT-CLOSE SLIDE 4670

- Self and soft closing
- With self & soft closing mechanism built-in, easy to install as with conventional slides
- Full extension (3 members)
- The drawer can be pulled out beyond the slide length for slide length above 350 mm

## SOFT-CLOSE SLIDE 5370

- For heavy duty
- A soft-closing rail for heavy weights (load capacity up to 100 kgf)
- Soft-closing spring force can be manually switched
- The inner member is detachable by lifting the lever

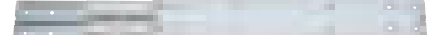
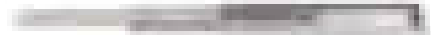

**FULL EXTENSION SLIDE  
ESR-3813**

- Full extension
- The drawer is detachable by lifting the lever
- The drawer can be held in the fully closed position with integrated bumper
- Non-handed

**FULL EXTENSION SLIDE  
ESR-DC4513**

- Full extension
- Front disconnect
- Positive stop
- Hold-in detent
- Non-handed

**FULL EXTENSION SLIDE  
ESR10**

- Heavy duty
- Full extension (3 members)
- Non-handed

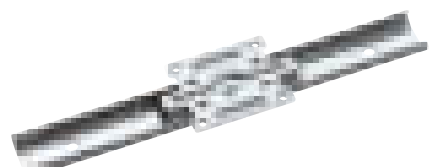
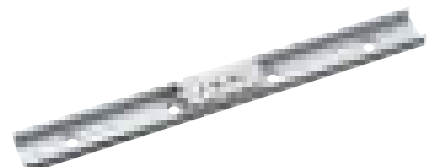
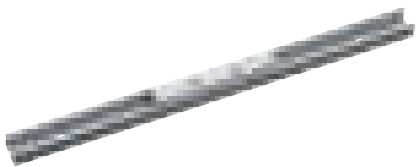

**MULTI-ROLLER LINEAR GUIDE  
MLG13**

- Slim type
- Allows for smooth movement with the unique mechanism called „multi-roller“
- Can be used vertically, horizontally or side ways
- Ideal for showcases

**MULTI-ROLLER LINEAR GUIDE  
MLG20**

- Mini type
- Allows for smooth movement with the unique mechanism called „multi-roller“
- Can be used vertically, horizontally or side ways
- Ideal for showcases

**MULTI-ROLLER LINEAR GUIDE  
MLGX25**

- For medium load
- The unique structure called „Dual X“ allows for smooth movement
- Can be used vertically, horizontally or side ways

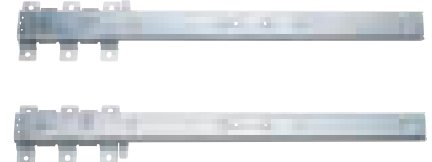

**MINI GUIDE RAIL  
MRS20**

- Does not need grease
- Very compact
- Made from anodized aluminium for high corrosion resistance
- Uses flame retardant material rated UL94HB

**GUIDE RAIL  
LGB30**

- Bearing roller used in guide block allows for smooth movement
- The guide block features a noise-reducing bearing roller using a plastic outer ring
- Clearance between the guide rail and guide block provides versatility

**DRAWER SLIDE  
C203V**

- The slides are mounted to the underside of drawers or decks
- Hidden from view when opened, unlike side-mount slides
- The outer member can be removed by operating the lever
- The main body is only 19.5 mm thick

# MISCELLANEOUS



## SPLIT CABLE GROMMET CHC-S

- Can be split into two parts for easy cable replacement
- Even when exchanging with cables which have bigger plugs than the grommet, there is no need to take apart them
- Non-split model (CHC) is also available



## SPLIT CABLE GROMMET LS50S-S

- Comes with a removable lid to fit most wires
- Can be split into two parts for easy cable replacement
- Even when exchanging with cables which have bigger plugs than the grommet, there is no need to take apart them



## ALUMINIUM VENTILATOR APK-K

- Smart and simple design
- Small holes prevents insects from entering
- 4 sizes and 4 finishes available

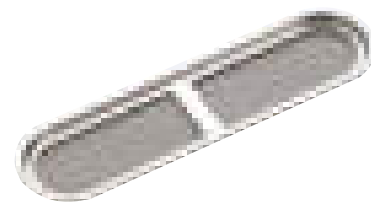

## VENTILATOR SAD

- Very thin mesh prevents insects from passing through
- Material: Stainless Steel (SUS304)
- 2 sizes available



## VENTILATOR SAM

- Very thin mesh prevents insects from passing through
- Material: Stainless Steel (SUS304)
- 5 sizes available



## RECESSED PULL WITH VENTILATOR UTA-105

- Dual function as handle and ventilator
- Ventilator is not visible from the front, providing a clean appearance
- Made from chemically resistant resin



## EXTENSION HANGER WH

- Space-saving, undermount design for narrow spaces.
- 4 sizes available
- Up to 6 kg of load capacity



## LEVELING GLIDE TG

- 3 sizes, 2 colours and 2 materials available
- Small but with high load capacity (up to 180 kg)
- GP type to prevent slipping
- Knurled rim for easy adjustment

STAINLESS  
304  
STEEL

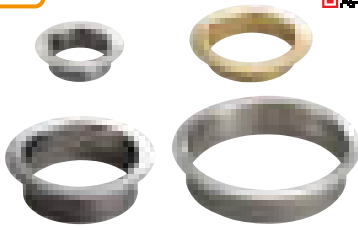

### RING COVER FOR REFUSE BOX AN-DH, AN-LH

- Without lid
- Corrosion resistant
- 4 sizes, 3 finishes and 2 depths available

STAINLESS  
304  
STEEL



### MULTI-PURPOSE LID AD-GD

- Lid equipped with damper
- Corrosion resistant
- Wide opening angle

STAINLESS  
304  
STEEL

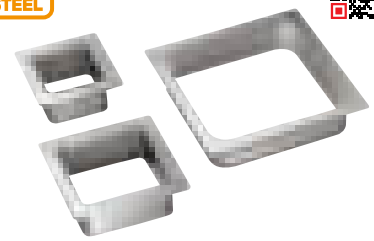

### SQUARE COVER FOR REFUSE BOX AN-KH

- Without lid
- Corrosion resistant
- 5 sizes available for various applications

STAINLESS  
304  
STEEL

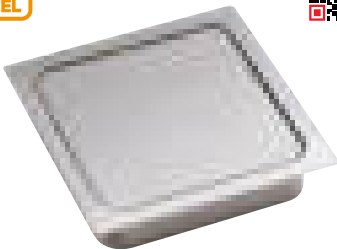

### MULTI-PURPOSE LID (W/DAMPER) AD-KH

- Lid is self and soft closing
- 3 sizes available
- Made of stainless steel for corrosion resistance. Available in areas exposed to water

STAINLESS  
304  
STEEL

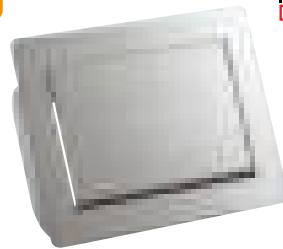

### MULTI-PURPOSE LID (W/DAMPER) AZ-GD232-HL

- Lid is self and soft closing
- Can be installed at angle of 85 to 45 degrees
- Installed with anti-pinching plates
- Corrosion resistant

STAINLESS  
304  
STEEL

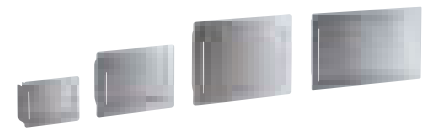

### MULTI-PURPOSE LID AZ-GD

- Lid is self and soft closing
- Installed with anti-pinching plates
- Corrosion resistant
- Available in 4 sizes and 2 finishes

STAINLESS  
304  
STEEL

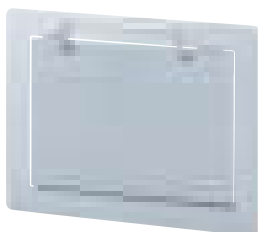

### MULTI-PURPOSE LID (W/HANDLE) AZ-HD

- Easy opening with handle
- Corrosion resistant for easy cleaning
- 2 sizes available

STAINLESS  
304  
STEEL



### FOLDING BRACKET EB

- Can be folded when not in use, allowing full use of space
- Automatically locks when flap is in opened position
- The lock can be easily released by pressing the lever
- In stainless steel in silver or black Damper version also available

STAINLESS  
304  
STEEL



### TRIANGLE BRACKET BK-TR

- A shelf bracket with a unique triangle design
- Clean design without visible mounting
- Cables can be wired through the inside of the bracket

# LAMP®

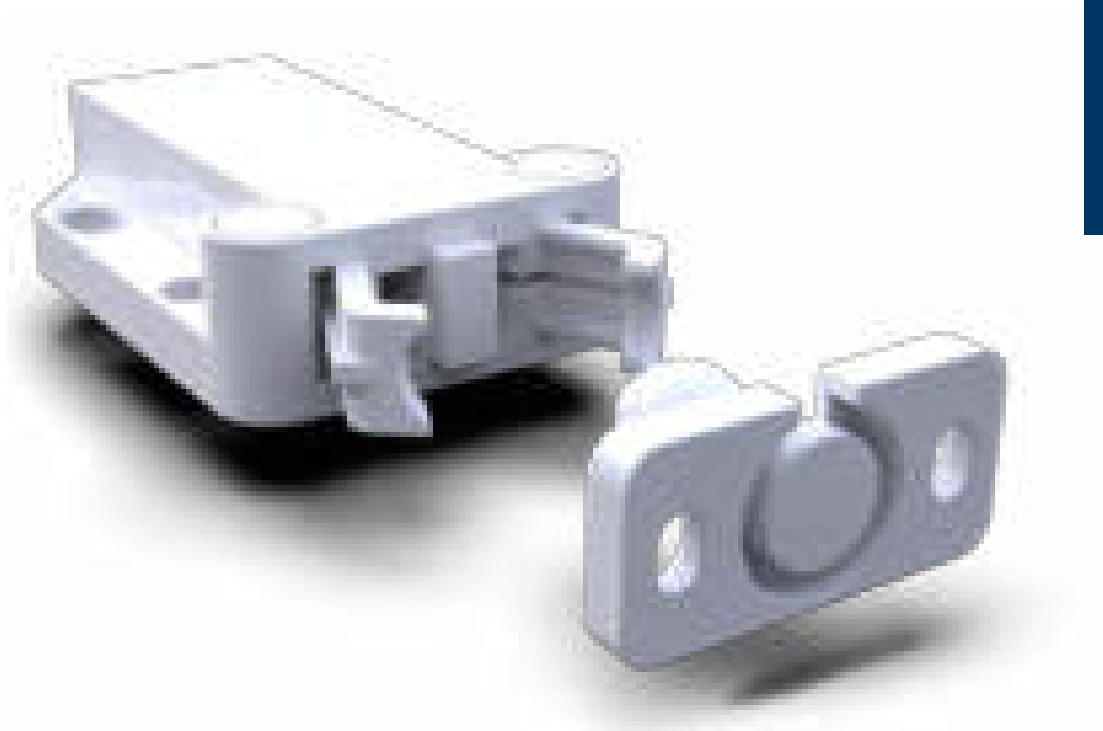

## SUGATSUNE EUROPE GMBH



Contact



sugatsune.eu

Manufacturer of the **LAMP®** Brand

T +49(0) 211-53812-900 E sales@sugatsune.eu Heerdter Lohweg 87-89 40549 Düsseldorf, Germany